

VR613HF

USER'S GUIDE

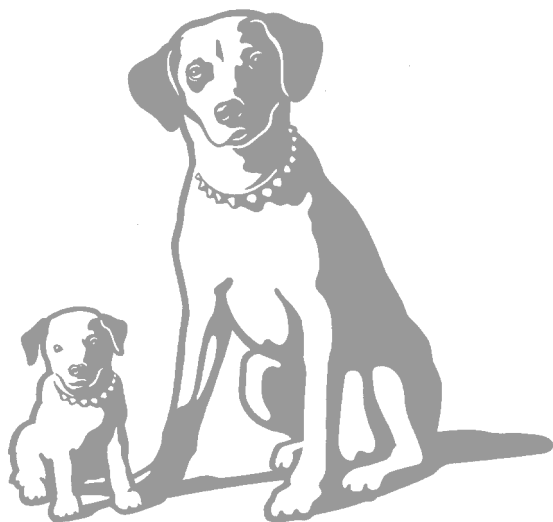

VIDEO CASSETTE **RECORDER**

TRISTAR

Important Information

WARNING

To reduce the risk of fire or shock hazard, do not expose this VCR to rain or moisture.

WARNING

**RISK OF ELECTRIC SHOCK
DO NOT OPEN**

TO REDUCE THE RISK OF ELECTRIC SHOCK, DO NOT REMOVE COVER (OR BACK). NO USER SERVICEABLE PARTS INSIDE. REFER SERVICING TO QUALIFIED SERVICE PERSONNEL.

 This symbol indicates "dangerous voltage" inside the product that presents a risk of electric shock or personal injury.

 This symbol indicates important instructions accompanying the product.

Cautions

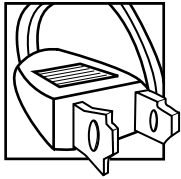

Caution: To prevent electric shock, match wide blade of plug to wide slot, fully insert.

Attention: Pour éviter les chocs électriques, introduire la lame la plus large de la fiche dans la borne correspondante de la prise et pousser jusqu'au fond.

Do not defeat the safety feature of the plug. The wide blade fits into the wall socket only one way. If you need an extension cord, make sure it matches the plug of the VCR.

For U.S.A. — Operate VCR only on 120 volts, 60Hz AC power (normal house power).

FCC Regulations state that unauthorized changes or modifications to this equipment may void the user's authority to operate it.

Note To Cable TV Installer

This reminder is provided to call your attention to Article 820-40 of the National Electrical Code (Section 54 of the Canadian Electrical Code, Part 1) which provides guidelines for proper grounding and, in particular, specifies that the cable ground shall be connected to the grounding system of the building as close to the point of cable entry as practical.

Product Registration

Please fill out the product registration card and return it immediately. Returning this card allows us to contact you if needed.

Keep your sales receipt to obtain warranty parts and service and for proof of purchase. Attach it here and record the serial and model numbers in case you need them. The numbers are located on the back of the VCR.

Model No. VR613HF

Serial No. _____

Purchase Date: _____

Dealer/Address/Phone: _____

Table of Contents

Important Information		Picture Search _____	19
Warnings _____	i	Slow Motion _____	19
Cautions _____	i	Pause for Stop-Action _____	19
Note to Cable TV Installer _____	i	Frame Advance _____	20
Product Registration _____	i	Automatic Tracking _____	20
		Manual Tracking _____	20
Hooking Up the VCR		Commercial Scan (SEARCH Button) _	21
Choosing a Hookup _____	2	Index Search _____	21
Antenna or Cable System Without a		Zero Search _____	22
Cable Box _____	3	Blank Search _____	22
Cable System With Cable Box to		TAPE PLAYBACK:	
Unscramble All Channels _____	4	HI-FI/MIX/LINEAR Feature _____	23
Cable System With Cable Box to			
Unscramble Only Pay Channels _____	5	Recording a Program	
Connecting Two VCRs for Copying Tapes _	6	Types of Recordings _____	24
Connecting a Stereo Amplifier/Receiver _	7	Recording Speeds _____	24
		Recording Pause _____	24
Setting Up the VCR		Basic Recording –	
Startup		Operating Instructions _____	24
Check Accessories With VCR _____	8	Watch a TV Channel While VCR	
Insert Batteries in Remote _____	8	is Recording a Different Channel _____	24
Turn on TV and VCR _____	8	Express Recording _____	25
Place Channels in VCR's Memory _____	9	Recording Broadcast Stereo TV or SAP ____	26
Add or Remove Channels from		Recording Audio Only _____	27
VCR's Memory _____	9	Recording While You're Away	
Select the Language/		Setting a Timer Recording _____	28
Seleccione el Idioma _____	10	Stopping a Timer Recording _____	28
Use TV•VCR Button _____	10	Timer Recording From the	
Set the AUTO TV/VCR Feature _____	10	VCR's Line Input _____	29
Set Display Panel Brightness _____	11	Checking or Clearing	
Set the Time and Date _____	11	Timer Recordings _____	29
Set the Automatic		Using Two VCRs for Copying	
Daylight-Saving Time _____	11	and Editing Tapes _____	30
		Copying and Editing Tapes Using	
Using the Remote Control		Compatible Remote _____	30
Component, VCR, TV, Cable Box			
Buttons _____	12-13	References	
Controlling a TV _____	14	Location of Controls	
Controlling a Cable Box _____	15	Front Panel _____	31
		Back Panel _____	31
Playing a Tape		Display Panel _____	32
Operating Instructions _____	16	Specifications _____	33
Using the Playback Features		Cleaning the VCR _____	33
Auto Play Feature _____	17	Trouble Checks _____	34-35
Auto Repeat Feature _____	17	Limited Warranty _____	36
DISPLAY Button _____	18	Index _____	37
Time Counter _____	18		

Choosing a Hookup

The hookups on pages 3 through 5 are divided into two hookup types: Basic (A) and Advanced (B).

The basic hookup shows the backs of TVs that have only an antenna/cable connection. It is the easier of the two and additional accessories may not be needed.

The advanced hookup shows the VCR hooked up to a monitor/receiver (TV with audio and video jacks) using a signal splitter. This connection may improve the picture quality as well as convenience of operation.

Answer the questions to choose the hookup for your VCR.

1. How do you receive your TV signals?

Choose one answer from below.

- A. Outside antenna – Turn to page 3.
- B. Rabbit ears (set-top) and/or bow tie antenna – Turn to page 3.
- C. Cable System – Go to question 2.

2. What type of Cable-TV system* do you have?

Choose one answer from below.

- A. Cable without a box – Turn to page 3.
- B. Cable box to unscramble all the channels – Turn to page 4.
- C. Cable box to unscramble only pay channels, such as HBO, Showtime, Cinemax, etc. – Turn to page 5.

*You may need to contact your local cable company for assistance.

Optional Hookups

How to hook up two VCRs for copying tapes?

- A. Select a hookup by answering questions 1 and 2 above.
- B. Then, modify the connections as shown on page 6.

How to hook up a stereo amplifier/receiver?

- A. Select a hookup by answering questions 1 and 2 above.
- B. Then, modify the connections as shown on page 7.

Antenna or Cable System Without a Cable Box

A. Basic hookup.

Use this hookup for a simple connection which requires fewer accessories.

1. **Set the 3CH.4 switch on back of VCR to either channel 3 or 4.**

Tune the TV to this channel and use the TV•VCR button to watch the VCR.

2. **Connect as shown.**

This connection may require additional accessories not provided.

3. **Plug in power cords of VCR and TV.**

4. **Continue to page 8.**

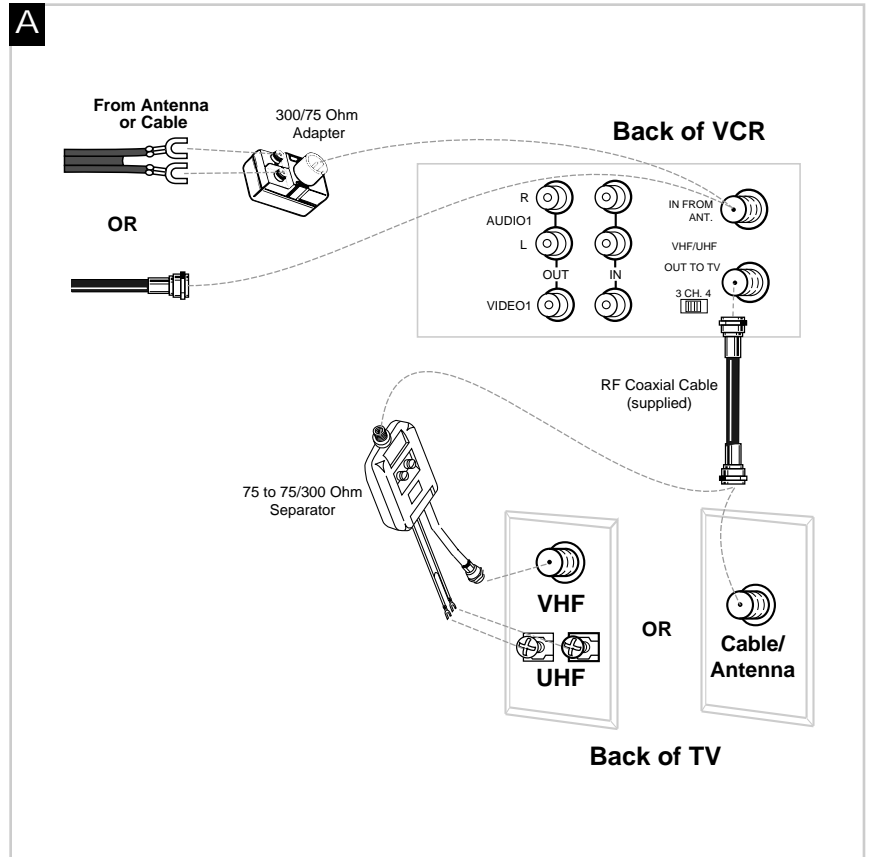

B. Advanced hookup.

Use this hookup for slightly improved picture quality and more convenient operation — use of the TV•VCR button is not required.

1. **Connect as shown.**

This connection requires additional accessories not provided.

If your TV is not stereo, a Y-adaptor may be required to hear sound from both channels.

2. **Plug in power cords of VCR and TV.**

3. **Continue to page 8.**

Tune the TV to its video input to watch the VCR.

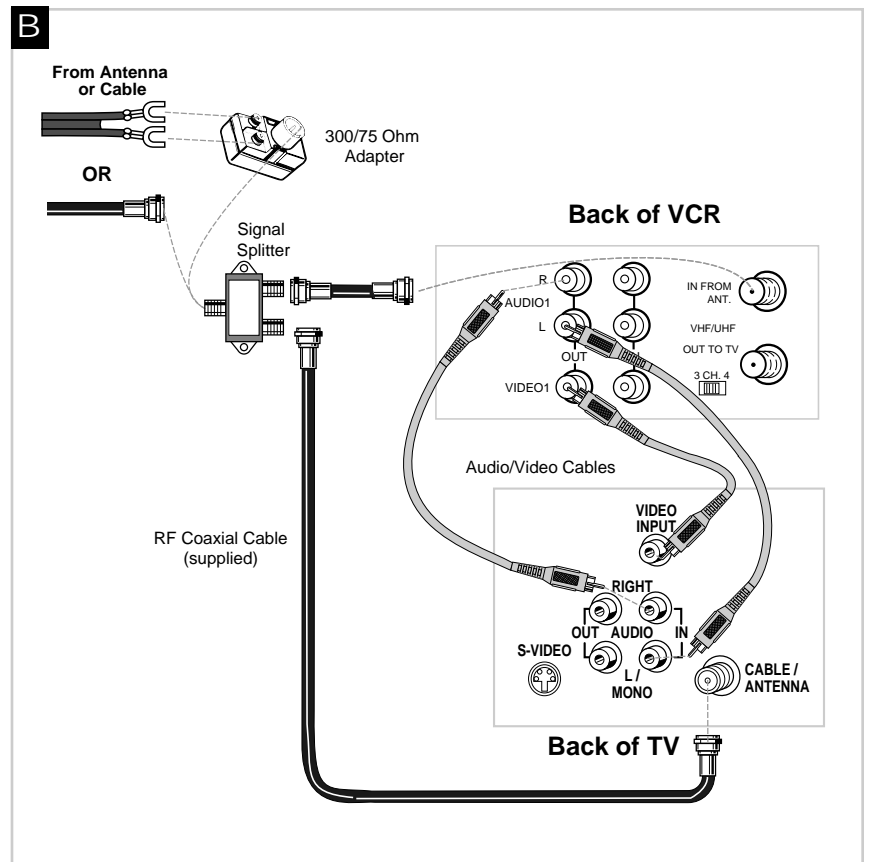

Cable System With Cable Box to Unscramble All Channels

A. Basic hookup.

Use this hookup for a simple connection which requires fewer accessories.

1. **Set the 3CH.4 switch on back of VCR to either channel 3 or 4.**

Tune the TV to this channel and use the TV•VCR button to watch the VCR.

2. **Connect as shown.**

This connection may require additional accessories not provided.

3. **Plug in power cords of VCR, TV, and cable box.**

4. **Continue to page 8.**

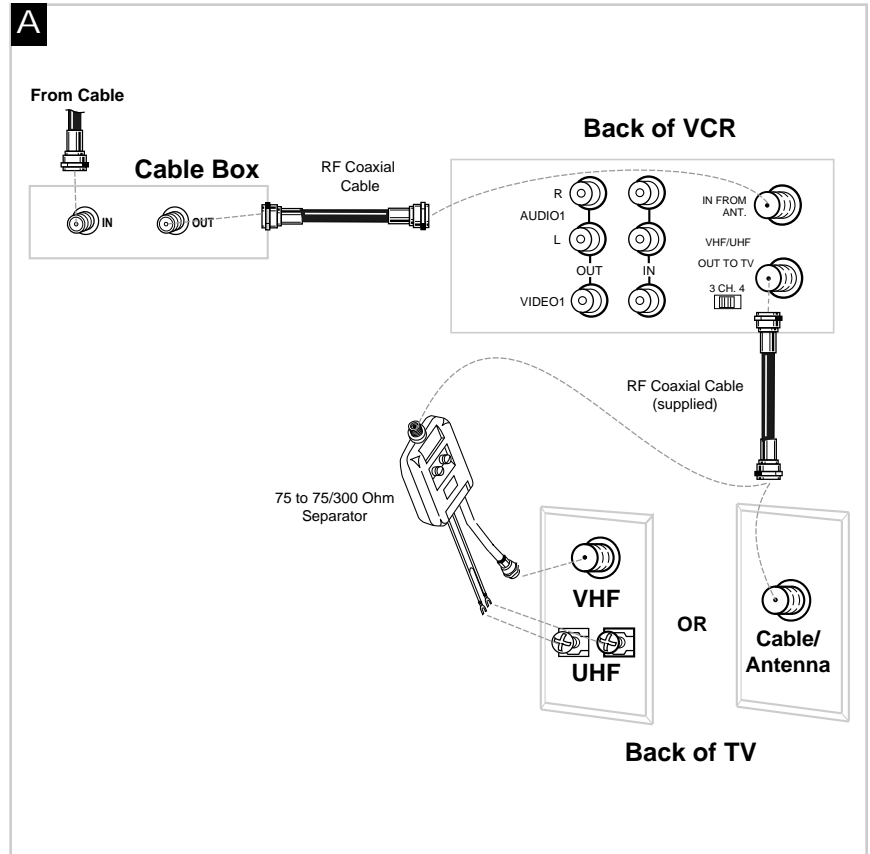

B. Advanced hookup.

Use this hookup for slightly improved picture quality and more convenient operation — use of the TV•VCR button is not required.

1. **Connect as shown.**

This connection requires additional accessories not provided.

If your TV is not stereo, a Y-adaptor may be required to hear sound from both channels.

2. **Plug in power cords of VCR, TV, and cable box.**

3. **Continue to page 8.**

Tune the TV to its video input to watch the VCR.

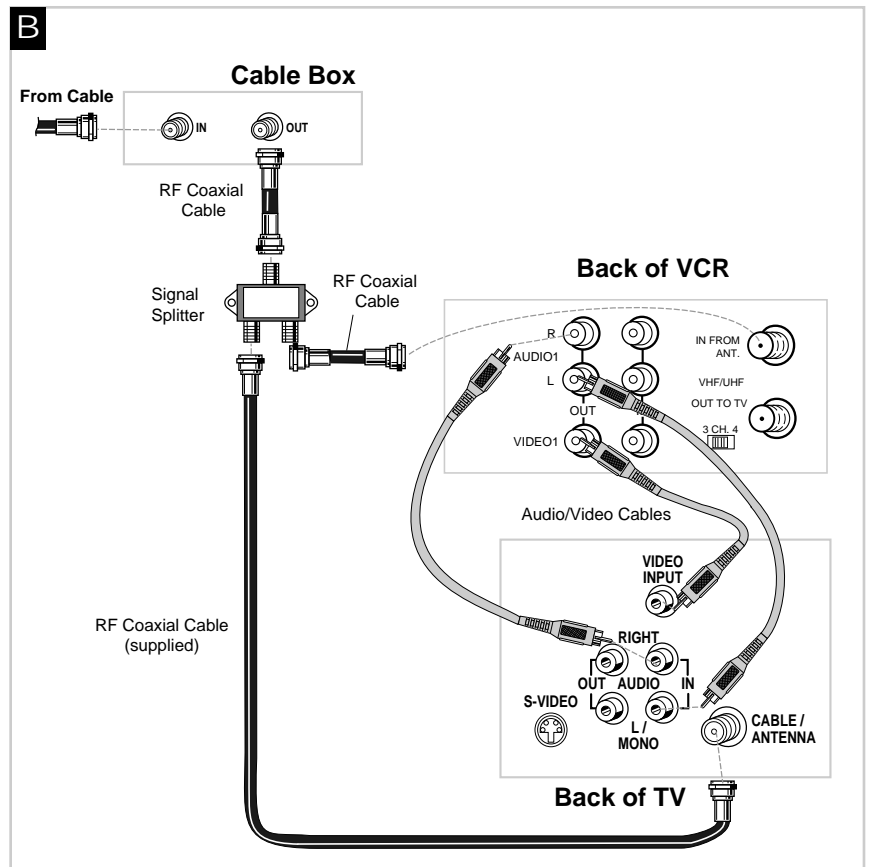

Cable System With Cable Box to Unscramble Only Pay Channels

(such as HBO, Showtime, Pay-Per-View, etc.)

A. Basic hookup.

Use this hookup for a simple connection which requires fewer accessories.

1. **Set the 3CH.4 switch on back of VCR to either channel 3 or 4.**

Tune the TV to this channel and use the TV•VCR button to watch the VCR.

2. **Connect as shown.**

This connection may require additional accessories not provided.

3. **Plug in power cords of VCR, TV, and cable box.**

4. **Continue to page 8.**

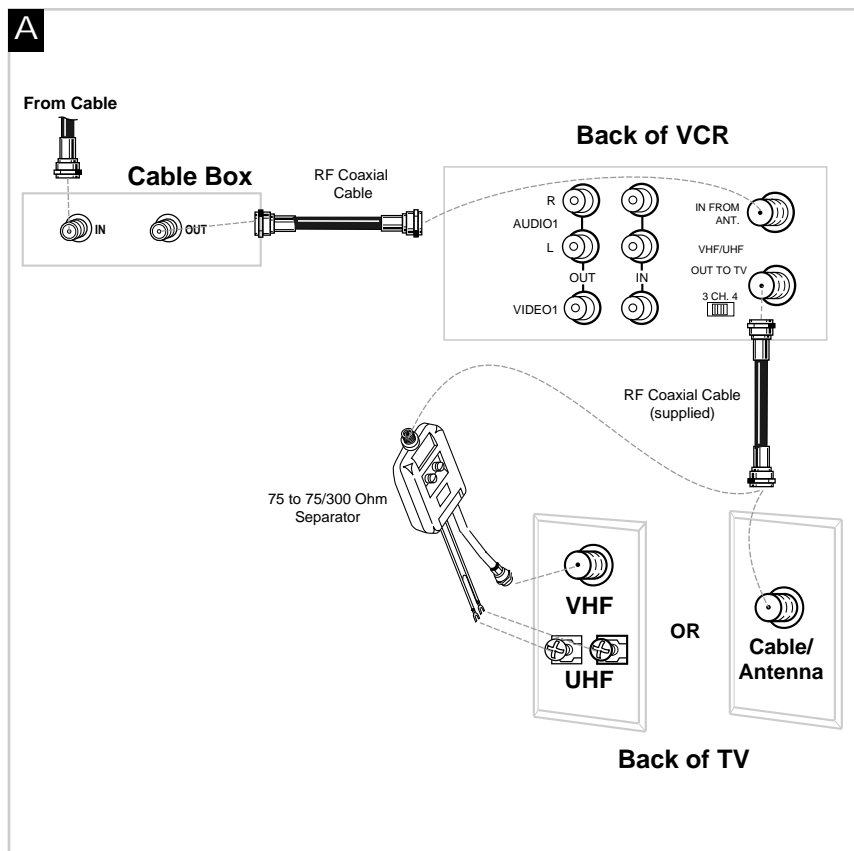

B. Advanced hookup.

Use this hookup for slightly improved picture quality and more convenient operation — use of the TV•VCR button is not required.

1. **Connect as shown.**

This connection requires additional accessories not provided.

If your TV is not stereo, a Y-adaptor may be required to hear sound from both channels.

2. **Plug in power cords of VCR, TV, and cable box.**

3. **Continue to page 8.**

Tune the TV to its video input to watch the VCR. View all pay channels through the VCR.

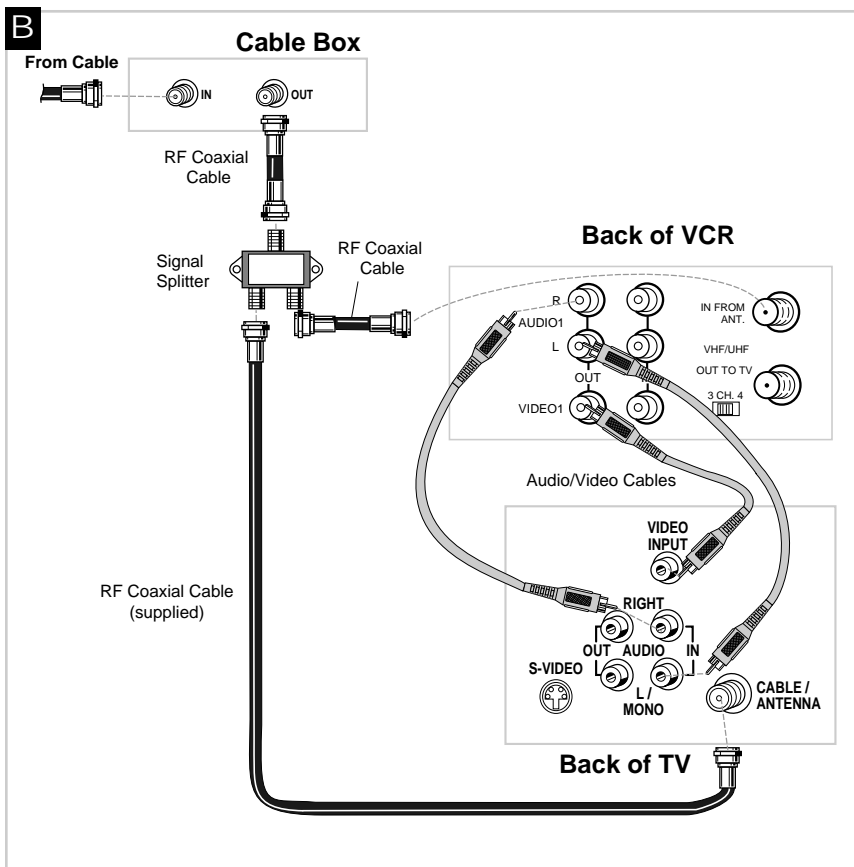

Connecting Two VCRs for Copying Tapes

Option A hookup.

Use this hookup for a simple connection which requires fewer accessories.

1. **Select a hookup from pages 2 through 5 and then modify with this connection.**
2. **Set the 3CH.4 switch on the playback VCR to either channel 3 or 4.**
Tune the recording VCR to this channel to receive the signal from the playback VCR.
3. **Connect as shown.**
This connection may require additional accessories not provided.
4. **Plug in power cords of VCRs and TV.**
5. **Continue to page 8.**

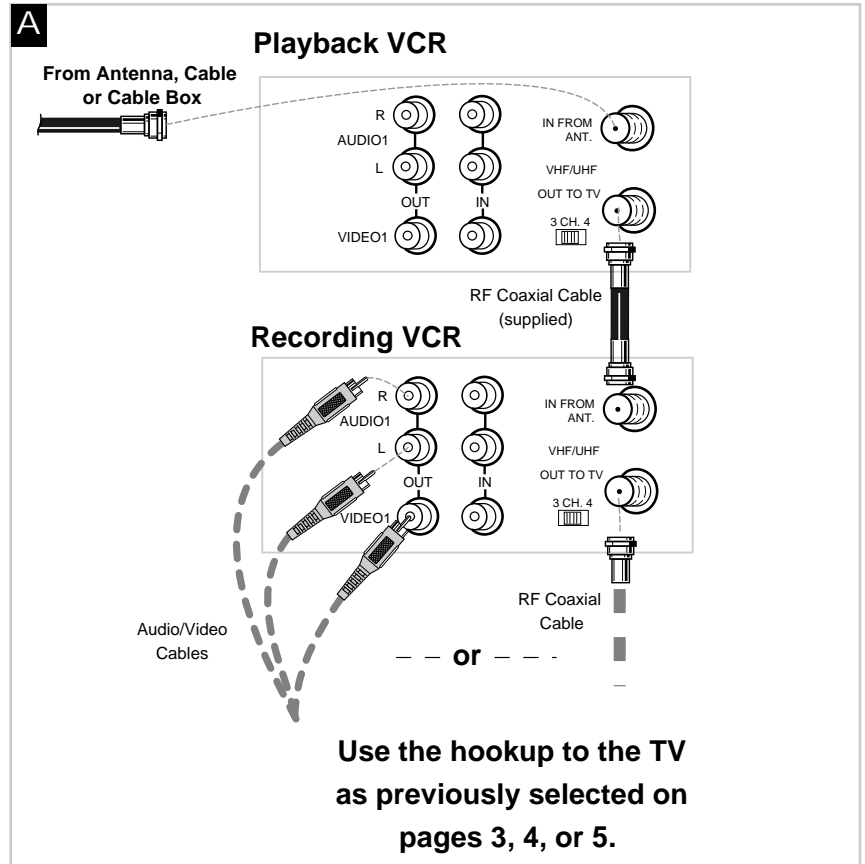

Option B hookup.

Use this hookup for slightly improved copy quality and more convenient operation — use of the TV•VCR button is not required.

1. **Select a hookup from pages 2 through 5 and then modify with this connection.**
2. **Connect as shown.**
This connection requires additional accessories not provided.
If your other VCR is not stereo, a Y-adaptor may be required to hear sound from both channels.
3. **Plug in power cords of VCRs and TV.**
4. **Continue to page 8.**

You will select the line (audio/video) input on the recording VCR to receive the signal from the playback VCR.

Caution: The unauthorized recording of television programs and other materials may infringe the rights of others.

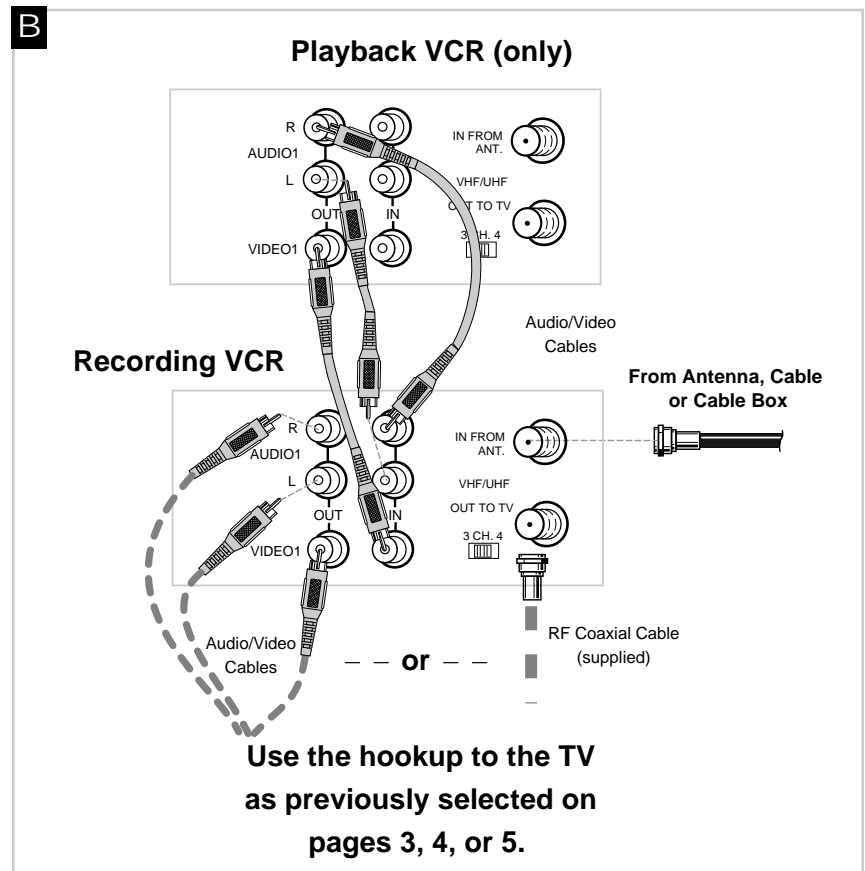

Connecting a Stereo Amplifier/Receiver

Record on the VCR from an amplifier/receiver.

Connect your VCR to a stereo amplifier/receiver to record stereo audio.

1. Select a hookup from pages 2 through 5 and then modify with this connection.

2. Connect as shown.

This connection requires additional accessories not provided.

3. Plug in power cords of amplifier/receiver, VCR, and TV.

4. Turn to page 27 for "Recording Audio Only."

Select the line input on the VCR to receive the audio signal from the amplifier/receiver.

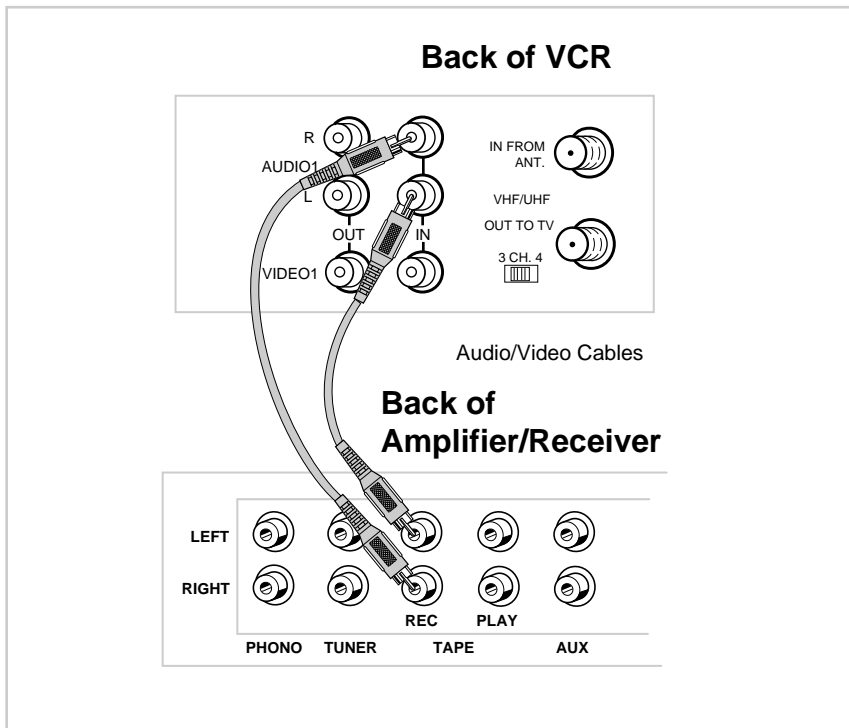

Play back stereo tapes or receive a stereo broadcast through an amplifier/receiver.

Connect your VCR to a stereo amplifier/receiver to receive stereo broadcasts or play back stereo tapes.

1. Select a hookup from pages 2 through 5 and then modify with this connection.

2. Connect as shown.

This connection requires additional accessories not provided.

3. Plug in power cords of amplifier/receiver, VCR, and TV.

4. Turn to page 16 for "Playback Operation."

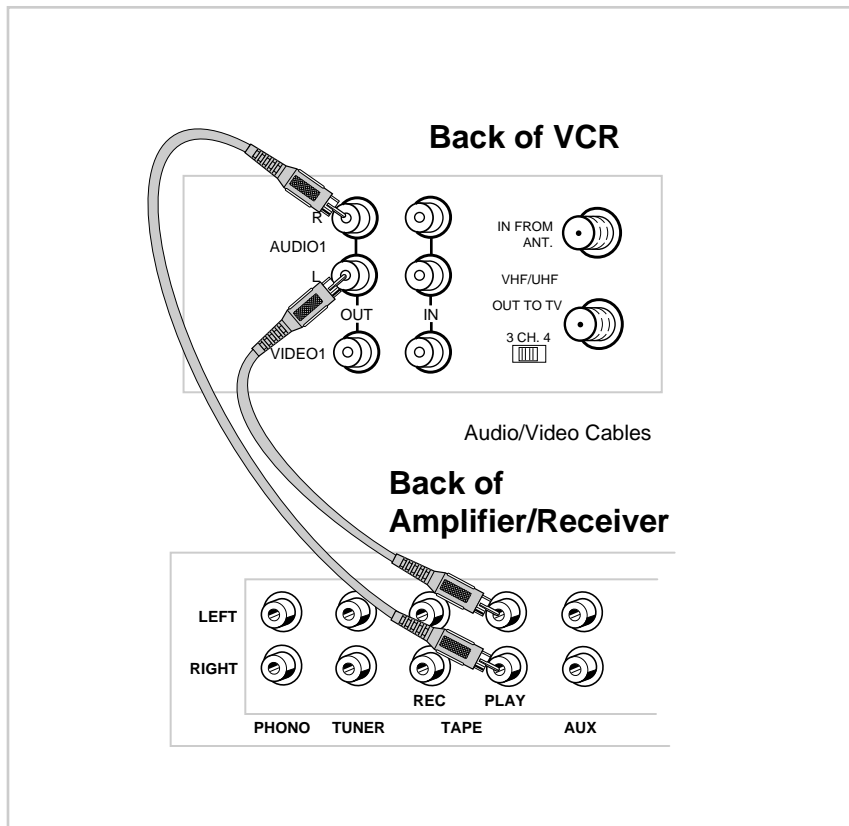

Startup

1. Check accessories with VCR.

Contact your dealer if any items are missing.

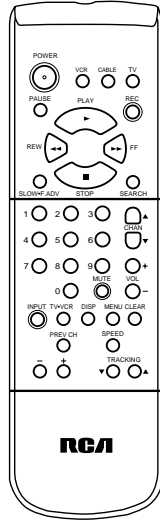

Remote
(Stock No. 221373)

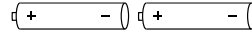

2 "AAA" Batteries



RF Coaxial Cable
(Stock No. 221346)

2. Insert batteries in remote.

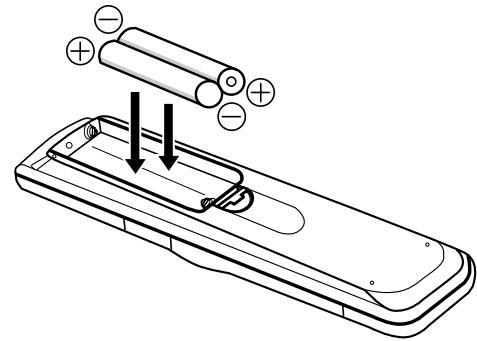
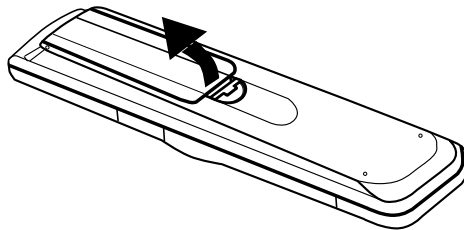

3. Turn on the TV.

- A. Turn on the TV.
- B. If you used one of the basic hookups, tune the TV to the channel selected with the 3CH.4 switch on back of VCR.
If you used one of the advanced hookups, tune the TV to the TV's video input.
(See TV owner's manual for details.)

4. Turn on the VCR.

- A. Press VCR on the remote. The POWER and VCR indicators in the VCR's display panel light.

Startup

5. Place channels in the VCR's memory.

The first time you turn on the VCR or after a power interruption, the VCR displays a message on the TV screen prompting you to AUTO CHANNEL SEARCH. If the message does not appear, go to step A below. If the message appears, follow the directions on the screen.

Wait until the channel numbers stop changing. This takes about one to two minutes. The TV tunes to the lowest channel found. Then, pressing CHAN up or down selects only the active channels.

If you ever need to manually SETUP CHANNELS on the VCR because you change cable or antenna signals:

- A. Press MENU to display the VCR MAIN MENU. If this menu does not appear:
 - Make sure the TV is tuned to same channel as the 3CH.4 switch on the VCR or the TV's video input (refer to TV's manual).
 - Press VCR, then press MENU again.
 - If you use a basic hookup, check the VCR indicator in display panel — it should be on. Press TV•VCR to turn it on.
 - Check the connections.
- B. Press 3 to display the CHANNELS menu.
- C. Press 1 to begin AUTO CHANNEL SEARCH.

The VCR automatically selects CABLE (cable TV) or ANTENNA. If you need to change the setting manually, press 3.

```
AUTO CHANNEL SEARCH
CONNECT ANTENNA CABLE...
THEN PRESS CH UP
```

```
VCR MAIN MENU
1 TIMER RECORDINGS
2 SET CLOCK
3 CHANNELS
```

```
CHANNELS
1 AUTO CHANNEL SEARCH
2 ADD/REMOVE CHANNELS
3 SIGNAL TYPE: CABLE

0 EXIT
```

6. Add or remove channels from the VCR's memory.

You may want to add or remove channels if some of the channels are not active, have weak signals, or you do not want to watch them.

You must place channels in memory using the AUTO CHANNEL SEARCH feature *described above* before you can add or remove channels.

- A. Press VCR.
- B. Press MENU on the remote to display the VCR MAIN MENU.
- C. Press 3 to display the CHANNELS menu.
- D. Press 2 to display the ADD/REMOVE CHANNEL menu.
- E. Follow the directions on the screen.
- F. Add or remove more channels using the CHAN up and down buttons.

```
VCR MAIN MENU
1 TIMER RECORDINGS
2 SET CLOCK
3 CHANNELS
```

```
CHANNELS
1 AUTO CHANNEL SEARCH
2 ADD/REMOVE CHANNELS
```

```
ADD/REMOVE CHANNEL

CHANNEL 03
IS PRESENTLY ADDED

PRESS CLEAR TO REMOVE
PRESS MENU TO EXIT
```

Startup

7. Select the language/seleccione el idioma.

This feature lets you select English or Spanish as the language for your on-screen menus.

- A. Press MENU on the remote to display VCR MAIN MENU.
- B. Press 6 to display the LANGUAGE/LENGUA menu.
 - Select 1 to have the menus displayed in English (Inglés).
 - Select 2 to have the menus displayed in Spanish (Español).

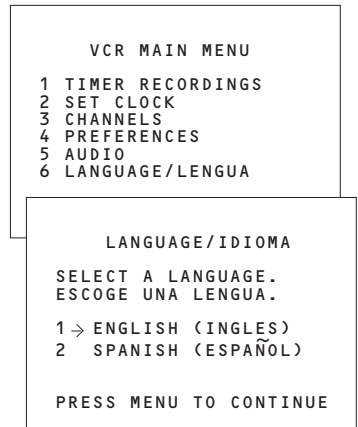

8. Use TV•VCR button.

Skip this step if you used one of the advanced hookups.

When using one of the basic hookups, the TV•VCR button lets you switch between the picture coming from the VCR or television channels. This button lets you record a program on the VCR while watching another channel on the TV. *Details are on page 24.*

- A. Press VCR to set the remote to control the VCR.
- B. Press TV•VCR to see the picture from the VCR. The VCR indicator lights in the display panel.
- C. Press CHAN up or down to change channels on the VCR. The channel number changes on the TV screen and in the display panel.
- D. Press TV•VCR to see the TV channels. The VCR indicator does not light in the display panel. Change channels using the TV's remote.
- E. Return the TV to the VCR viewing channel — CH3 or CH4.
- F. Press TV•VCR to switch back to the picture from the VCR.

9. Set Auto TV/VCR feature.

Skip this step if you used one of the basic hookups.

If you connected your VCR using the video input of your TV, you can prevent the VCR indicator from turning on automatically.

- A. Press MENU on remote to display VCR MAIN MENU.
- B. Press 4 to display PREFERENCES.
- C. Press 3 to select AUTO TV/VCR: ON or OFF.
 - Select ON if you used one of the basic hookups and watch your VCR on channel 3 or 4 of your TV. Then, you press the TV•VCR button to turn the VCR indicator on or off to switch between the picture coming from the VCR or television channels.
 - Select OFF if you used one of the advance hookups and watch your VCR on the video input channel of your TV. The VCR indicator does not turn on automatically.

Pressing TV•VCR on the remote turns the VCR indicator on or off.

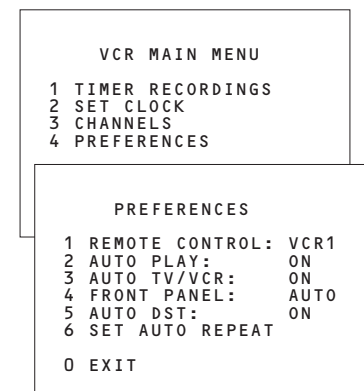

Startup

10. Set the display panel brightness.

This VCR lets you change the brightness level of the fluorescent display panel.

- A. Press MENU on remote to see the VCR MAIN MENU.
- B. Press 4 to display the PREFERENCES menu.
- C. Press 4 to select a FRONT PANEL mode.
 - Select AUTO to keep the display panel bright when VCR is on and dim when it is off.
 - Select BRITE to keep the display panel bright.
 - Select DIM to keep the display panel dim.

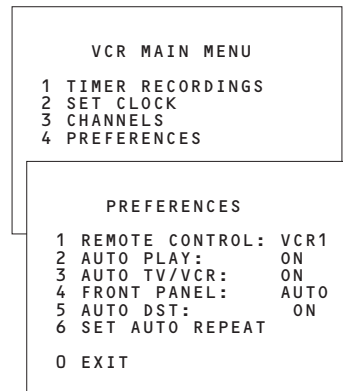

11. Set the time and date.

When you first turn on the VCR, --- appears in the clock area of the VCR's display panel.

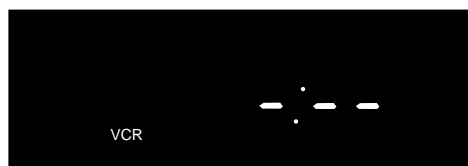

- A. Press MENU on remote to display VCR MAIN MENU.
- B. Press 2 to display SET CLOCK.
- C. Enter the time and date with the number buttons on the remote.
 - Press 0 before single-digit numbers.
 - Example: press 0, then 5, then 0, then 7 for a time of 5:07. Press 1 for AM or 2 for PM.
 - Press CLEAR on the remote to change incorrect entries.
- D. Press MENU on the remote to start the clock and remove the SET CLOCK menu from the screen. The time appears in the VCR's display panel, and the time and date appear on the TV screen when you press DISP on remote.

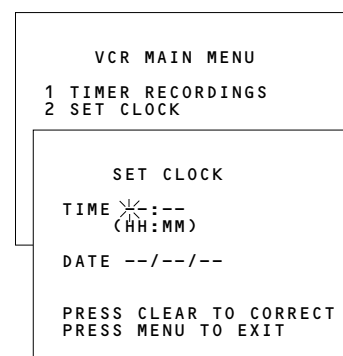

12. Set the Automatic Daylight-Saving Time

Select this feature if you want the VCR's clock to advance one hour in April and reverse one hour in October automatically.

- A. Press MENU on the remote to display the VCR MAIN MENU.
- B. Press 4 to display the PREFERENCES menu.
- C. Press 5 to select a AUTO DST mode.
 - Select ON if you want the VCR's clock to adjust for Daylight Saving Time automatically.
 - Select OFF if you do *not* want the VCR's clock to adjust for Daylight Saving Time automatically.

In the Spring, daylight-saving time begins on the first Sunday in April. Clocks are set forward one hour.

Because the clock changes automatically from 2:00 AM to 3:00 AM, keep in mind that any part of a scheduled Timer Recording that falls between these two times will not be recorded.

In the autumn, daylight-saving time begins on the last Sunday in October. Clocks are set back one hour.

The VCR clock automatically changes from 2:00 AM to 1:00 AM. Therefore, it affects your recording length.

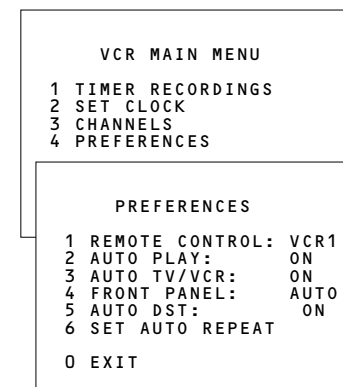

Buttons

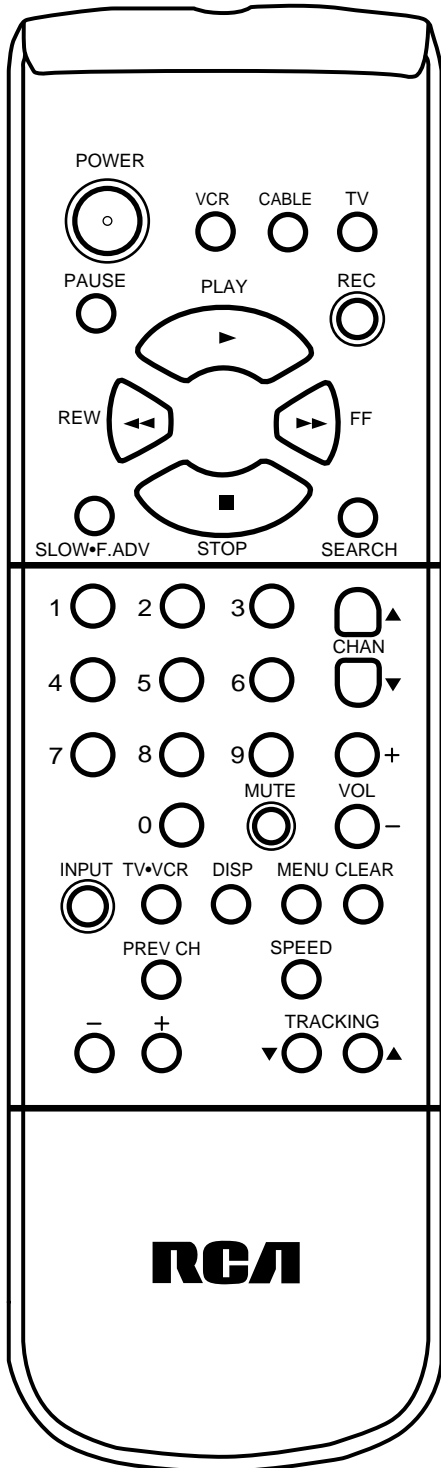

Component Buttons

Press one of the buttons to set the remote to operate that component.

CABLE

Used with the POWER button to turn on a compatible cable box. See page 15.

TV

Turns on a compatible RCA, ProScan or GE TV, and sets the remote to control the TV.

Used with the POWER button to turn on another brand of TV when the remote is programmed to control that TV. See page 14.

VCR

Sets the remote to control the VCR.

VCR Function Buttons

Press VCR to set remote to control the VCR to use the function buttons.

CHAN (Channel) Up or Down

Selects the next higher or lower channel in the VCR's channel memory.

CLEAR

Resets the time counter to 0:00:00.

Lets you change entries when setting the clock or VCR for a timer recording.

DISP (Display)

Shows VCR operating displays on the TV screen.

Displays the time counter.

FF (Fast Forward)

Fast forwards the tape when the VCR is stopped.

Quickly searches a tape in forward motion during playback.

INPUT

Turns the line input (L) on or off.

Line input refers to the signal coming from the component connected to the audio/video jacks on the back of the VCR.

MENU

Displays the VCR MAIN MENU on the TV screen.

Removes a menu from the screen.

Numbers (0 through 9)

Selects a channel up to 99—press two numbers.

Selects a cable channel over 99—press and hold 1—appears on the screen. Then, press the other two numbers.

PAUSE

Pauses action for viewing during playback.

Pauses recording to prevent recording of unwanted scenes.

PLAY

Plays a tape.

POWER

Turns off the VCR when the remote is set to control the VCR.

Buttons

VCR Function Buttons

(continued)

PREV CH (Previous Channel)

Switches between two channels.

Select one channel and then select another. Press PREV CH to switch between the two channels.

REC (Record)

Starts the VCR recording.

Used for express recording. See page 25.

REW (Rewind)

Rewinds the tape when the VCR is stopped.

Quickly searches a tape in reverse motion during playback.

SEARCH

Displays the INDEX, ZERO, and BLANK search menus on the TV screen.

Advances a tape 60 or 120 seconds during playback.

SLOW•F. ADV (Frame Advance)

Plays a tape in slow-motion.

Advances a tape one frame at a time with each press of the button when tape is in stop-action pause.

SPEED (Tape Speed)

Selects a recording speed (SP, LP, SLP).

STOP

Stops the VCR's normal functions such as record, playback, rewind, fast forward, and pause.

TRACKING Up or Down

Reduces the streaks that may appear on the picture during play, slow, or pause.

Reduces picture "jitter" during stop-action playback.

TV•VCR

Switches the picture signal so that it either comes from the VCR or the TV channel. See page 10.

TV Function Buttons

Press the TV button to set remote to control a compatible TV. Some buttons may not work with the TV.

+/-

Operates the TV menus on some RCA TVs.

CHAN (Channel) Up or Down

Selects next higher or lower channel in the TV's channel memory when remote is set to control a TV.

CLEAR

Removes menus or status displays from the screen.

DISP (Display)

Shows the status displays on the screen.

Removes menus or displays from the screen.

POWER

Turns off a compatible TV when remote is set to control that TV.

Used with the TV button to turn on a compatible TV that the remote has been programmed to control. See page 14.

MUTE

Turns the TV sound on or off.

Numbers (0 through 9)

Selects a channel up to 99—press two numbers.

Selects a cable channel over 99—press and hold 1 until 1-- appears on the screen. Then, press the other two numbers.

PREV CH (Previous Channel)

Switches between two channels.

Select one channel and then select another. Press PREV CH to switch between the two channels.

VOL (Volume) Up or Down

Raises and lowers sound.

Cable Box Receiver Function Buttons

Press the CABLE button to set remote to control a compatible cable box. Some buttons may not work with the cable box.

CHAN (Channel) Up or Down

Selects next higher or lower channel in the cable box's channel memory when remote is set to control it.

Numbers (0 through 9)

Selects a channel.

POWER

Turns off a compatible cable box receiver when remote is set to control it.

Controlling a TV

The VCR's remote is preprogrammed to control the basic functions of a compatible RCA, ProScan, or GE TV. Also, you can set up the remote to control other manufacturer's brands. To program the remote, enter the remote code numbers that correspond to your brand.

Program the Remote for a TV

1. Turn on the TV.
2. Point the VCR remote at the TV.
3. To enter the code for your brand, hold the TV button and press two number buttons. If the TV changes channels when you press CHAN up or down, setup is complete.
4. Release the buttons.
5. Repeat steps 2 – 4 with a different code if the first one does not work.

Brand *	Code Number(s)	Brand *	Code Number(s)
Akai	03	NAD	07,08
AOC	06,12	NEC	06,12
Candle	06	Panasonic	04,11
Citizen	06	Philco	04,06,12
Colortyme	06	Philips	03,04,06
Concerto	06	Pioneer	06
Curtis Mathes	01,06	Portland	06,12
Daewoo	06,12	ProScan	01
Daytron	06	Proton	06
Electrohome	06,12	Quasar	11
Emerson	06	Radio Shack	01,05,13
Envision	05,06	RCA	01,06,12
Fisher	05	Realistic	05
GE	00,01,06,11	Sampo	06
Goldstar	06,12	Samsung	06,09,12
Hallmark	06	Sanyo	05
Hitachi	06,14	Sears	01,05,06,07,08,10
Infinity	04	Sharp	06,13
J C Penney	00,01,06,09,12	Sony	03
JBL	04	Soundesign	06
Jensen	06	Sylvania	04,06
JVC	10,11	Technics	11
Kawasho	03,06	Techwood	06
Kenwood	06	Teknika	06
Loewe	04	TMK	06
Luxman	06	Toshiba	05,07,08,09
LXI	04,05,07	Universal	00
Magnavox	04,06	Victor	10
Marantz	04	Wards	00,01,04,06,12,13
Marantz	04,06	Yamaha	12
MGA	06,12	Zenith	02
Mitsubishi	06,12		
MTC	06, 12		

Helpful Hint: Notice the difference between the TV and VCR on-screen displays. This is one way to tell if the remote is set to control the VCR or the TV.

* The remote may not be able to control every model TV of the brands listed.

Operate the TV

After you set up your remote to control your TV, test the TV buttons to see which ones operate your TV.

1. Point the remote at the TV and press TV.
2. If the TV does not turn on in step 1, press TV, then POWER.
3. Use the "TV Function Buttons" as described on page 13.

Controlling a Cable Box

The CABLE button on the VCR's remote is preprogrammed to control a compatible RCA cable box. If your cable box is another manufacturer's brand and has its own remote, you will probably be able to program the VCR's remote to control your cable box. To program the VCR's remote, enter the code that corresponds to your brand.

Program the remote

1. Turn on the cable box.
2. Point the VCR remote at the cable box.
3. Hold the CABLE button and press two number buttons to enter the code for your brand.
4. Release the buttons.
5. Press POWER on the remote. If the cable box turns off, setup is complete.
6. Repeat steps 2 – 4 with a different code if the first one does not work.

Brand of Cable-TV Box	Code Number(s)
ABC	53, 54
Anvision	07, 08
Cablestar	07, 08
Diamond	56
Eagle	07, 08
Eastern International	02
General Instrument	04, 05, 15, 23, 24, 25, 30, 36
Hamlin	12, 13, 34, 48
Hitachi	37, 43
Jerrold	04, 05, 15, 23, 24, 25, 30, 36, 45, 46, 47
Macom	37, 43
Magnavox	07, 08, 19, 26, 28, 29, 32, 33, 40, 41
NSC	09
Oak	01, 16, 38
Oak Sigma	16
Panasonic	03, 27, 39
Philips	07, 08, 19, 26, 28, 29, 32, 33, 40, 41
Pioneer	18, 20, 44
Randtek	07, 08
RCA	00, 27
Regal	12, 13
Regency	02, 33
Samsung	44
Scientific Atlanta	03, 22, 35
Starquete 2000	58
Sylvania	11, 59
Teknika	06
Texscan	10, 11, 59
Tocom	17, 21, 49, 50, 55
Unika	31, 32, 41
Universal	51, 52
Viewstar	07, 08, 19, 26, 28, 29, 32, 33, 40, 41
Warner Amex	44
Zenith	14, 42, 57

* The remote may not be able to control every cable box of the brands listed.

Operate the Cable Box

After you set up your remote to control your cable box, test the buttons to see which ones operate your cable box.

1. Point the remote at the cable box and press CABLE.
2. If the cable box does not turn on in step 1, press CABLE, then POWER.
3. Use the "Cable Box Function Buttons" for the cable box. See page 13.

Operating Instructions

To play a tape

1. Turn on the TV and tune it to channel 3, 4, or the TV's video input to see the picture from the VCR.
2. Insert a tape in the VCR.
The VCR turns on automatically. The VCR indicator lights if the AUTO TV/VCR feature is turned ON. Tape begins playback automatically if the safety tab on the cassette has been removed and the AUTO PLAY feature is turned on.

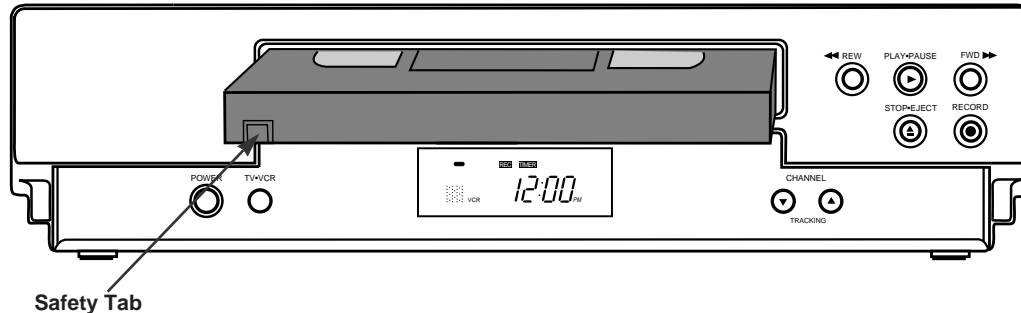

3. Press PLAY•PAUSE on the VCR or PLAY on the remote if necessary.
▶ appears in the VCR's display panel.
4. Press TRACKING up or down on the remote or VCR to remove any streaks from the picture if necessary. *Details are on page 20.*
5. Press STOP•EJECT on the VCR or STOP on the remote.
6. Press REW.
The VCR automatically rewinds the tape if it reaches the end of the tape during playback. Also, if you press POWER while a tape is rewinding, the VCR turns off automatically when it is completely rewound.
7. Press STOP•EJECT on the VCR to eject the tape once it is completely rewound.

Using the Playback Features

AUTO PLAY Feature

This feature lets you tell the VCR whether to automatically start playing when you insert a tape with its safety tab removed.

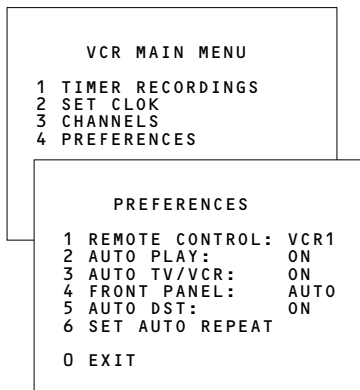

1. Press MENU on the remote to display the VCR MAIN MENU.
2. Press 4 to display the PREFERENCES menu.
3. Press 2 to select AUTO PLAY: ON or OFF.
 - Select ON if you want a tape with its safety tab removed to start playing automatically.
 - Select OFF if you do *not* want a tape with its safety tab removed to start playing automatically.

AUTO REPEAT Feature

When you set this feature, the VCR plays a tape, for the amount of time you specify, over and over. For example, if you enter a length of two hours, the VCR will play the tape for two hours, automatically rewind the tape, and play the tape again.

1. Press MENU on the remote to display the VCR MAIN MENU.
2. Press 4 to display the PREFERENCES menu.
3. Press 6 to display the SET AUTO REPEAT menu.
4. Set the length of time you want the tape to play in a repeating loop.

Press CLEAR on the remote to correct the length.

 - Select a length of 0:00 with the CLEAR button if you do not want the tape to repeat.
 - If the time you enter exceeds the actual length of the tape, the VCR will play to the end of the tape.
 - Ejecting the tape will cancel the repeat feature.

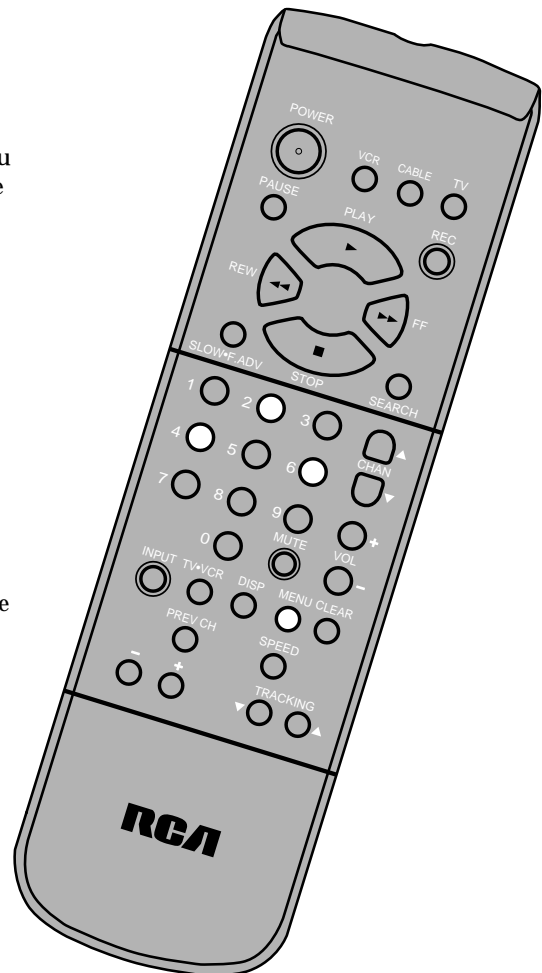

Using the Playback Features

DISP (Display) Button

1. Press DISP to display the status of the VCR, channel number, time counter, date, time, and tape speed on the TV screen.
You must set the time and date before they can be displayed. If you do not press DISP again, this display times out.
2. Press DISP again to continually display the time counter on the TV screen. The time counter appears instead of the time in the VCR's display panel.
3. Press DISP again to remove the time counter from the screen. No displays appear on the TV screen and the time counter remains in the VCR's display panel. This is convenient for editing tapes.
4. Press DISP again to return to the normal status displays. The clock appears in VCR's display panel.
Turning off the VCR automatically returns the displays to normal.

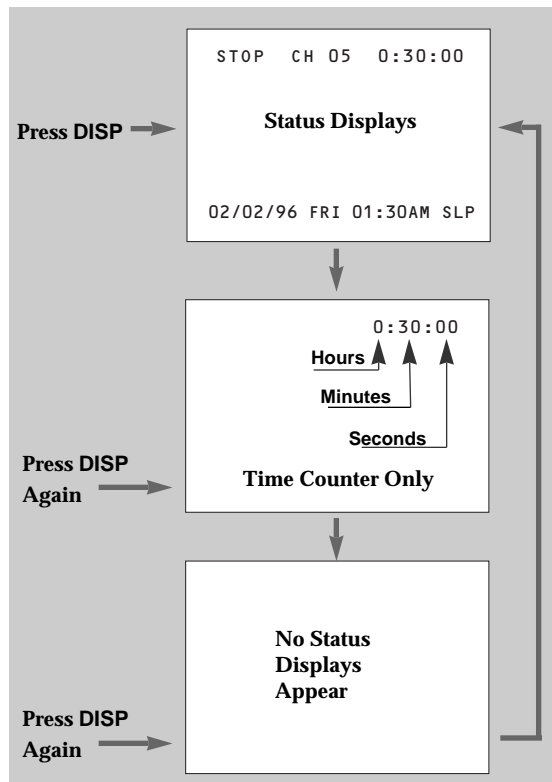

Time Counter

The time counter shows the actual time it takes to record a program or play back a segment of a prerecorded tape. This helps you locate the beginning or end of programs you taped. The time counter resets to 0:00:00 when the tape is ejected from the VCR.

For example, if you recorded a 30-minute program at the beginning of the tape, you would:

1. Insert the prerecorded tape.
2. Press DISP twice to display only the time counter on the TV screen.
3. Press FF to fast forward the tape until 0:30:00 appears in the time counter.
4. Press STOP.

This is the approximate end of the program. You can begin recording a new program.

5. Press CLEAR to reset the time counter to 0:00:00.
6. Press DISP to remove the time counter from the screen. These displays time out.

The time counter is removed from the TV screen during picture search.

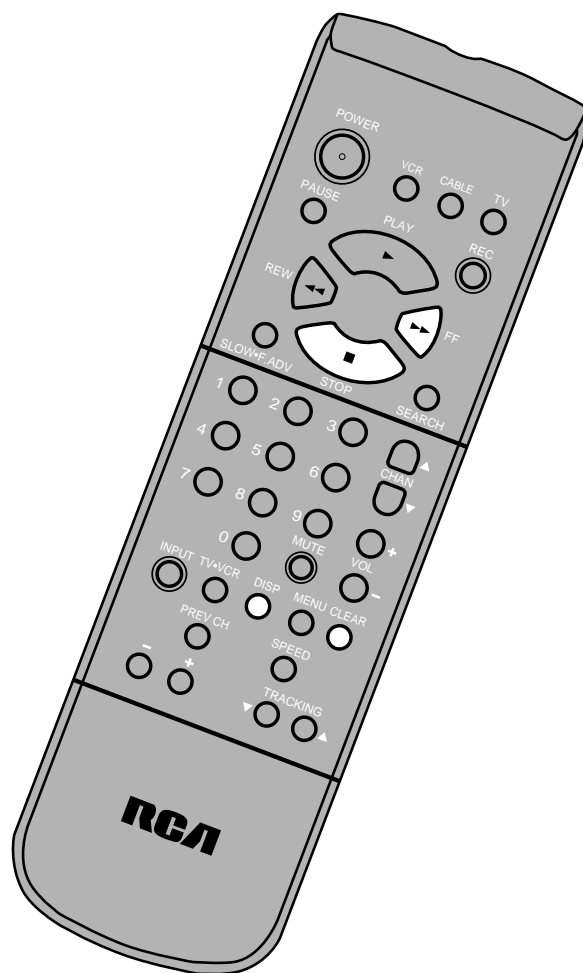

Using the Playback Features

Picture Search

You can search for a specific tape location during playback by fast forwarding or rewinding the tape. Sound is turned off during picture search. The time counter is removed from the TV screen during picture search. Picture search works best for tapes recorded in the SP or SLP speed.

Fast Forward Search

1. Press FF to search forward at a faster-than-normal speed.
2. Press FF or PLAY to return to playback.

Rewind Search

1. Press REW to search backward at a faster-than-normal speed.
2. Press REW or PLAY to return to playback.

Slow Motion

You can view a tape in slow motion during play or play pause. The + and — buttons let you vary the speed. Sound is turned off during slow-motion playback. Slow motion works best in the SP or SLP speed.

1. Press SLOW•F. ADV to begin slow-motion playback.
2. Press + to increase the speed or — to decrease the speed.
3. Use TRACKING up or down to remove any streaks from the picture.
4. Press PLAY on the remote or PLAY• PAUSE on the VCR to return to normal playback.

The VCR automatically switches from slow-motion playback to stop after a few minutes.

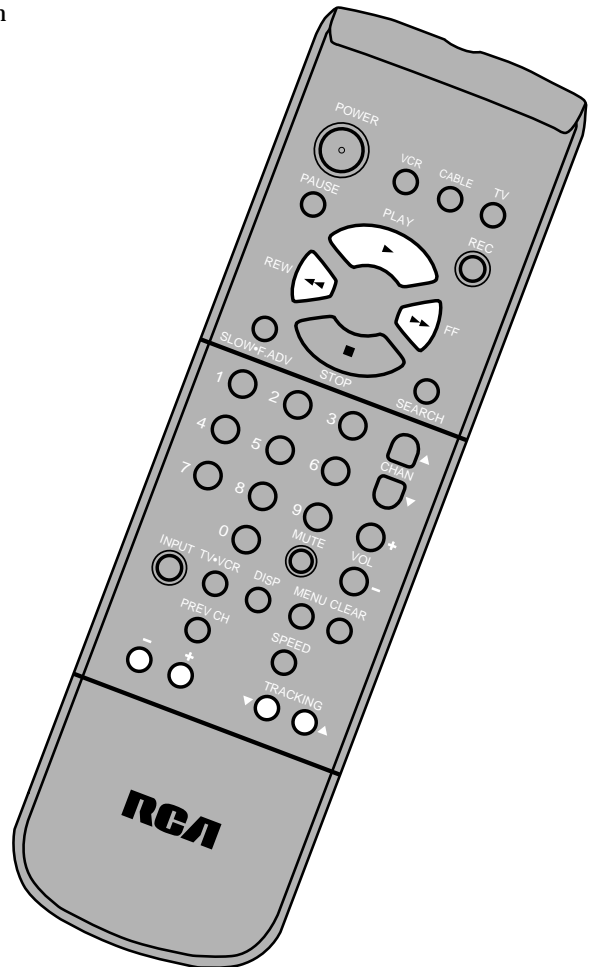

Using the Playback Features

Pause for Stop Action

This feature stops the tape in action and lets you examine the details of the scene on the screen. Stop action works best for tapes recorded in the SP or SLP speed.

1. Press PAUSE on the remote or PLAY•PAUSE on the VCR during playback to stop the action.
II appears in the VCR's display panel.
2. Press TRACKING up or down to reduce any jittering of the picture.
3. Press PAUSE or PLAY on the remote or PLAY•PAUSE on the VCR to return to playback.

The VCR automatically switches from stop-action playback to stop after a few minutes.

Frame Advance (SLOW•F. ADV Button)

Frame advance lets you view one stop-action frame after another. Frame advance works best for tapes recorded in the SP or SLP speed.

1. Press PAUSE or PLAY on the remote or PLAY•PAUSE on the VCR to stop the action.
2. Press SLOW•F. ADV when you want to view the next frame of the scene.
3. Press PAUSE or PLAY on the remote or PLAY•PAUSE on the VCR to resume normal playback.

Automatic Tracking

The VCR has automatic tracking which adjusts the picture when you play a tape recorded on another VCR. Automatic tracking is turned on when a tape is inserted or the VCR's power is turned on.

Manual Tracking

Occasionally, you may need to manually adjust tracking on a tape recorded on a different VCR or camcorder. Tracking is used when playing a tape. It has no effect during recording.

When streaks or snow appear in the picture, press TRACKING

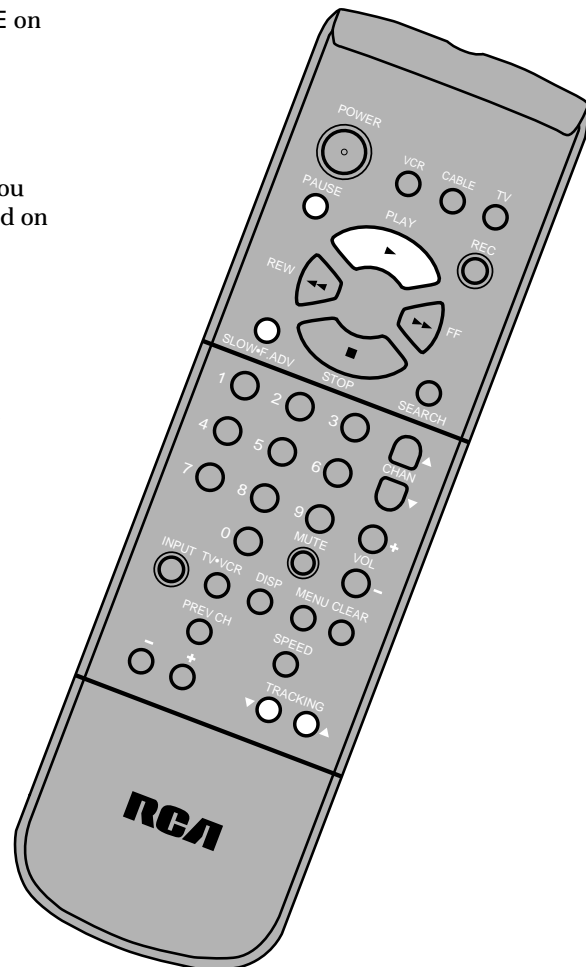

Using the Playback Features

Commercial Scan (SEARCH Button)

This is useful for scanning commercials or short program segments.

1. Press SEARCH once during playback to advance the tape approximately 60 seconds.

Index Search

The VCR has a "VHS Index Search System" that automatically records an index mark on the tape every time you stop and start recording. You can locate the program you want to play by the number of index marks.

The VCR automatically locates the index number you select. Then, the VCR searches forward or reverse from the current location on the tape.

Some index marks may be missed by the VCR.

- A mark too close to the current location on the tape.
- The mark at the beginning of a recorded segment of five minutes or less.
- The first index mark on the tape when you start searching from the beginning of the tape.

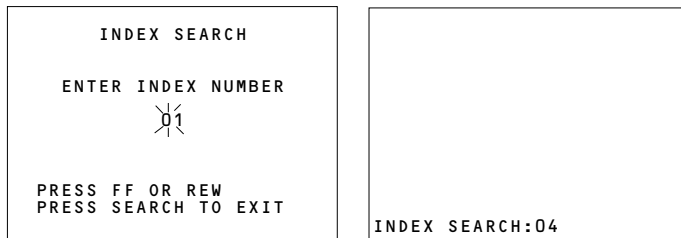

To index search:

1. Insert the prerecorded tape and press STOP.
2. Press SEARCH on the remote to display the INDEX SEARCH menu on the TV screen.
3. Press two number buttons to enter the number of index marks you want the VCR to search.
Press CLEAR on the remote to correct an entry.
4. Press FWD on the VCR or press FF on the remote to search forward or REW to search backward.
5. Press STOP to stop index searching.

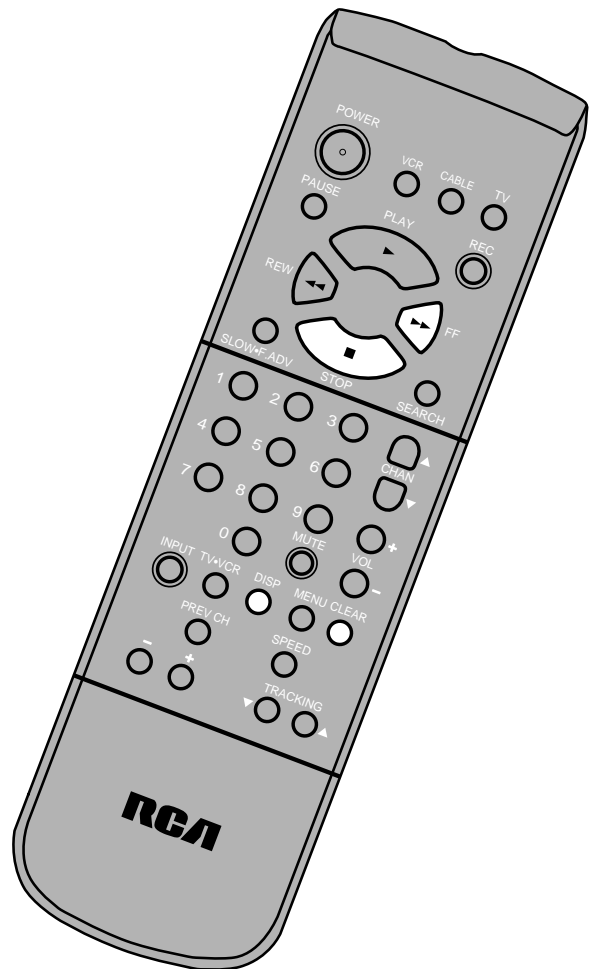

Using the Playback Features

Zero Search

The zero search feature lets you quickly return to a counter reading of 0:00:00 from anywhere on a tape. This is especially convenient when you want to watch a segment of the tape several times.

1. Insert the prerecorded tape.
2. Press DISP twice to display only the time counter on the TV screen.
3. Press PLAY•PAUSE, FWD on the VCR or FF on the remote, or REW to locate the place on the tape where you want to return quickly.
4. Press CLEAR to reset the time counter to 0:00:00.
5. Continue playing the tape.
6. Press STOP.
7. Press SEARCH twice in the stop mode to display the ZERO SEARCH menu on the TV screen. The current time counter appears.
8. Press REW or FWD on the VCR, or FF on the remote to return to 0:00:00. The time counter remains in the upper right corner of the TV screen during search.

```
ZERO SEARCH
CURRENT TAPE COUNTER IS
2:17:25

PRESS REW TO GO TO 0:00
PRESS SEARCH TO EXIT
```

```
ZERO SEARCH
CURRENT TAPE COUNTER IS
-2:17:25

PRESS FF TO GO TO 0:00
PRESS SEARCH TO EXIT
```

Blank Search

The VCR searches for blank portions of the tape that are more than six seconds long.

```
BLANK SEARCH

SEARCH FOR BLANK AREA

PRESS FF TO BEGIN
PRESS SEARCH TO EXIT
```

1. Insert the prerecorded tape. Press STOP.
2. Press SEARCH three times to display the BLANK SEARCH menu.
3. Press FWD on the VCR or FF on the remote to begin searching for six seconds of blank tape. A message appears on the screen if a blank area is not found.
4. Press STOP to stop BLANK searching.

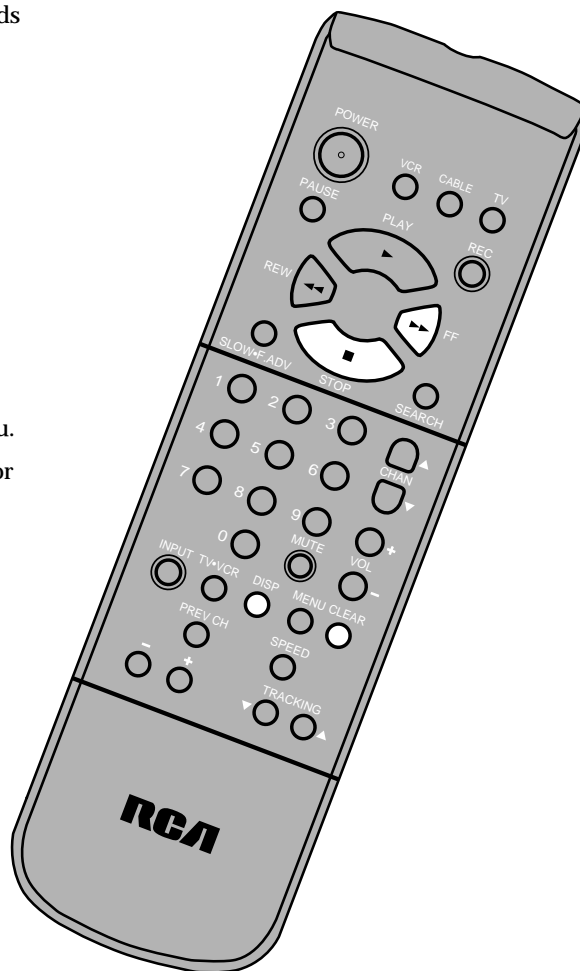

Using the Playback Features

TAPE Playback: HI-FI/MIX/LINEAR Feature

The VCR records the same audio on both the Hi-Fi and linear tracks on the tape. The Hi-Fi sound is recorded on separate left and right stereo channels. Monaural sound is recorded on the linear track.

To enjoy Hi-Fi sound, connect your VCR to a stereo television or amplifier/receiver using the audio/video jacks. The TAPE PLAYBACK: HI-FI/MIX/LINEAR feature lets you select which audio you play back.

To Select Playback Sound

1. Press MENU to display the VCR MAIN MENU.
2. Press 5 to display the AUDIO menu on the TV screen.
3. Press 2 to switch between HI-FI, MIX, or LINEAR sound.
 - Select HI-FI to play back sound recorded on the Hi-Fi track and for normal use.
The Hi-Fi indicator lights in the VCR's display panel.
 - Select MIX to play back the sound recorded on both the Hi-Fi and linear track, sound-on-sound.
The Hi-Fi indicator lights in the VCR's display panel.
 - Select LINEAR to play back the sound recorded on the linear monaural track, such as a second audio program (SAP).
The Hi-Fi indicator turns off in the VCR's display panel.

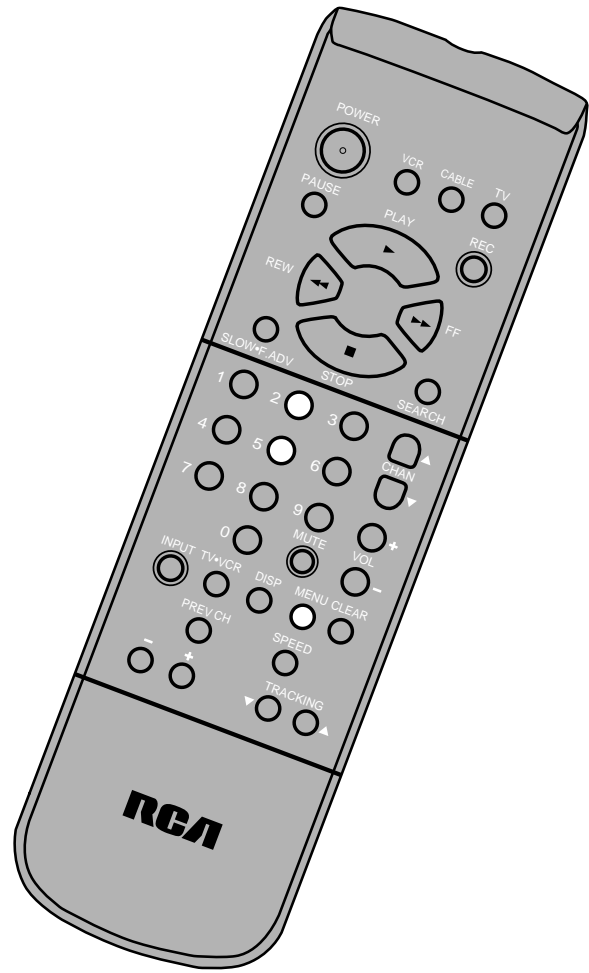
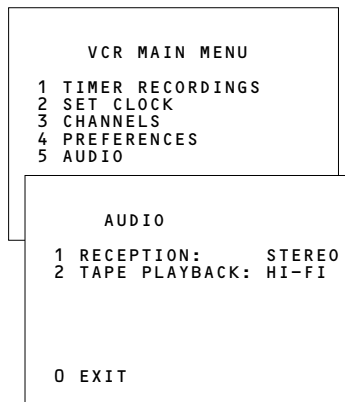

Types of Recordings

Your VCR provides different recording features. The following sections describe these features.

Recording Speeds

Press **SPEED** on the remote to select a recording speed (SP, LP, or SLP). This speed you select appears on the TV screen.

SP (Standard Play) gives the best quality recording. That is why most prerecorded, rental tapes are recorded in SP. Fewer programs can be recorded on the tape. Special effects such as pause, slow motion, picture search, and frame advance work well in this speed.

LP (Long Play) gives twice the recording time of tapes recorded in SP. Special effects in playback are not recommended in LP.

SLP (Super Long Play) gives three times the recording time of tapes recorded in SP. Special effects such as pause, slow motion, picture search, and frame advance work well in this speed.

Cassette	Recording Time		
	SP	LP	SLP
T-120	2Hr	4Hr	6Hr
T-160	2Hr 40Min	5Hr 20Min	8Hr

Recording Pause

This feature lets you prevent recording short sections of unwanted material.

Press **PAUSE** on the remote or **PLAY•PAUSE** on the VCR during recording to stop and start recording.

REC and **■** appear in the VCR's display panel.

The VCR automatically switches from pause to stop after a few minutes.

Basic Recording – Operating Instructions

To Make a Recording

Turn on the TV and tune it to the VCR viewing channel, either 3, 4, or the TV's video input channel.

1. Insert a tape with its safety tab in place.
2. Press **VCR** to set the remote to control the VCR.
3. If you are using one of the basic hookups, make sure the VCR indicator appears in the VCR's display panel. If not, press **TV•VCR** to turn it on.
4. Select the recording speed using **SPEED** on the remote. The tape speed indicator appears on the TV screen.
5. Select the channel to be recorded. The channel number appears in the VCR's display panel and on the TV screen.
6. Press **REC** on the remote or **RECORD** on the VCR to begin recording.
REC and **▶** appear in the VCR's display panel while the VCR is recording.

Watch a TV Channel While the VCR is Recording a Different Channel

1. Follow steps 1 through 6 above.
2. If you are using one of the basic hookups, press **TV•VCR** to switch to the TV channel. The VCR indicator turns off in the display panel.
3. Press **TV** to set the remote to control TV functions for a compatible TV.
4. Select the channel you want to watch with the TV's channel buttons.
5. Press **STOP•EJECT** on the VCR or **STOP** on remote when the recording is finished.

Express Recording

Express recording lets you record up to four hours without using the timer program feature. The VCR turns off automatically at the end of the recording.

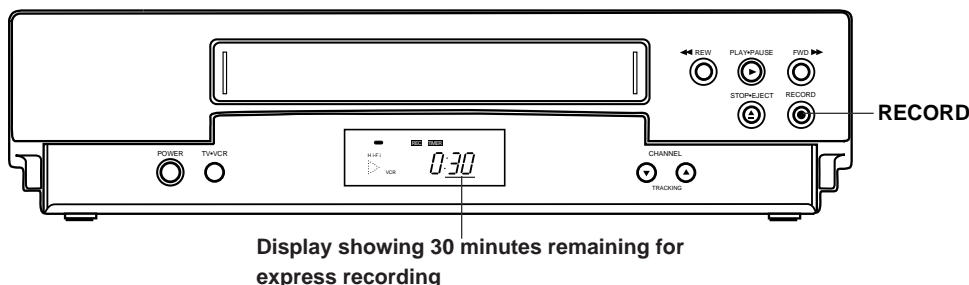

Operating Instructions

1. Turn on the VCR.
2. Insert a tape with its safety tab in place.
3. Select the channel you want to record.
4. Press SPEED on the remote to select a recording speed.
5. Press RECORD on the VCR or REC on the remote to start the recording.
6. Press RECORD or REC repeatedly until the amount of recording time for the program is displayed in the VCR's display panel or on the TV screen.

Each press of RECORD or REC increases the time — 30 minutes up to 4 hours.

The amount of time the VCR will record, and the **REC**, **▶**, and **TIMER** indicators appear in the VCR's display panel.

	Press RECORD	Recording Time
	0:30	(30 Min)
	1:00	(1 Hr)
	1:30	(1 Hr, 30 Min)
	2:00	(2 Hrs)
	3:00	(3 Hrs)
	4:00	(4 Hrs)

Display on TV Screen

During recording, press RECORD on the VCR or REC on the remote to display the time remaining on the TV screen. Press RECORD or REC again to increase the recording time.

Stopping a Recording in Progress

With the VCR: Press STOP•EJECT.

With the Remote: Press STOP.

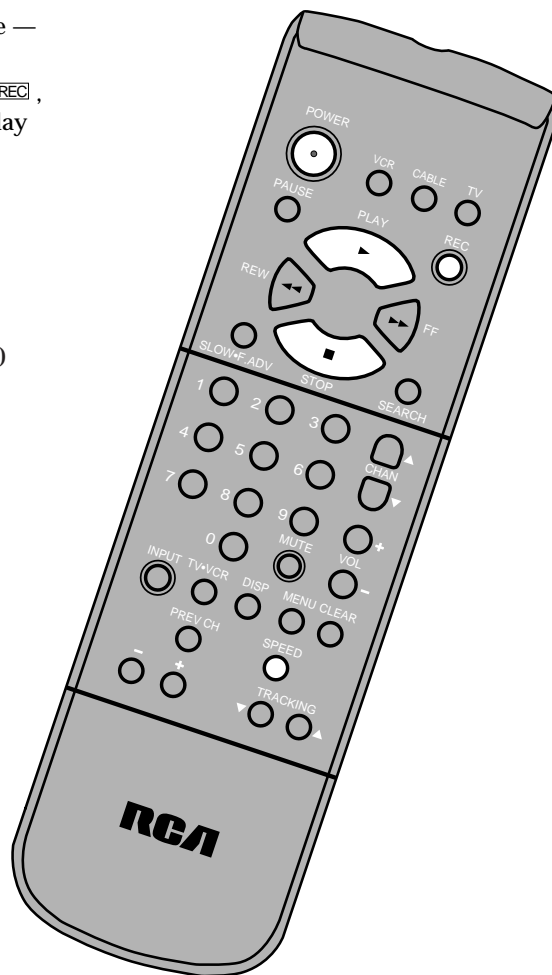

Stereo Broadcast TV or SAP (Second Audio Program)

Some TV programs are broadcast with stereo audio or a second audio language (SAP).

The RECEPTION: STEREO/SAP/MONO feature lets you select the type of audio you want to record.

To record stereo broadcast TV or SAP

Turn on the TV and tune it to the VCR viewing channel, either 3, 4, or the TV's video input.

1. Insert a tape with its safety tab in place.
2. If you are using one of the basic hookups, make sure the VCR indicator appears in the VCR's display panel. If not, press TV•VCR to turn it on.
3. Press SPEED on the remote to select a recording speed.
The tape speed indicator appears on the TV screen.
4. Select the channel or line input (L) to be recorded.
Channel number or L appears in the VCR's display panel.
5. Set the RECEPTION: STEREO/SAP/MONO feature for the type of audio you want to record.

A. Press MENU to display the VCR MAIN MENU.

B. Press 5 to display the AUDIO menu.

C. Press 1 to select the type of audio RECEPTION: STEREO, SAP, or MONO.

- Select STEREO for normal recording and to record broadcast stereo TV.



The STEREO indicator lights in the VCR's display panel when the station you are tuned to is broadcasting stereo.

- Select SAP to record SAP (second audio program) instead of the normal audio.

The SAP indicator lights in the VCR's display panel when the station you are tuned to is broadcasting SAP.

Set the TAPE PLAYBACK: HI-FI/MIX/LINEAR feature to LINEAR to hear SAP. *Details are on page 17.*

- Select MONO if the stereo signal is weak and the sound is too "noisy".

6. Press RECORD on the VCR or REC on the remote to start recording.  and  appear in the VCR's display panel.
7. Press STOP•EJECT on the VCR or STOP on the remote when you are finished.

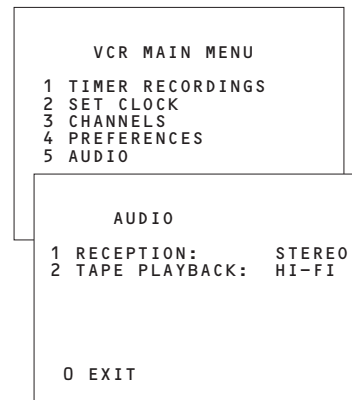

Recording Audio Only

You can record audio only from another audio source connected to the AUDIO1 IN (L and R) jacks on the back of the VCR.

To Record Audio Only *(Refer to hookup on page 7.)*

1. Press the INPUT button on the remote until the line indicator (L) appears in the VCR's display panel.
Then, the VCR can record audio from the audio equipment connected to the AUDIO1 IN jacks.
2. Press SPEED on the remote to select the recording speed.
The tape speed indicator appears on the TV screen.
3. Start playing the audio source. Then, press RECORD on the VCR or REC on the remote to begin recording.
REC and ► appear in the VCR's display panel.
4. Press STOP•EJECT on the VCR or STOP on the remote when you are finished.

Recording While You're Away (Timer Recording)

The timer program feature lets you program the VCR to record up to eight different programs within a one year period. Before setting the timer, make sure that:

- The clock is set correctly.
- A tape with its safety tab in place has been inserted with enough tape to record the programs.
- The remote is set to control the VCR — using VCR.

Setting a Timer Recording

1. Press MENU on the remote to display the VCR MAIN MENU.
2. Press 1 to display the TIMER RECORDINGS menu.
3. Press 1 to display the CREATE A NEW PROGRAM menu.
4. Press 1, 2, 3, or 4 to select type of program.
 - 1 ONE TIME — single program recorded once.
 - 2 DAILY — program recorded at same time every day.
 - 3 WEEKDAYS — program recorded at same time Monday through Friday.
 - 4 WEEKLY — program recorded at same time once a week.
5. Press number buttons on the remote to enter the channel number (or INPUT on the remote to select line input), start time including AM or PM, end time, and start date of the recording. Follow the on-screen prompts.

Press CLEAR on the remote to correct an entry.
6. Press SPEED on the remote to select the recording speed.
7. Press MENU to enter your program. A reminder appears which times out, or you can press MENU to return to the TIMER RECORDINGS.
8. Repeat steps 3–7 for additional programs or press MENU twice to remove the menu from the TV screen.
9. If using a cable box, leave it turned on and tuned to the channel you want to record. Otherwise, **turn off the VCR** before the recording begins.

TIMER appears in the VCR's display panel when the timer has been programmed.

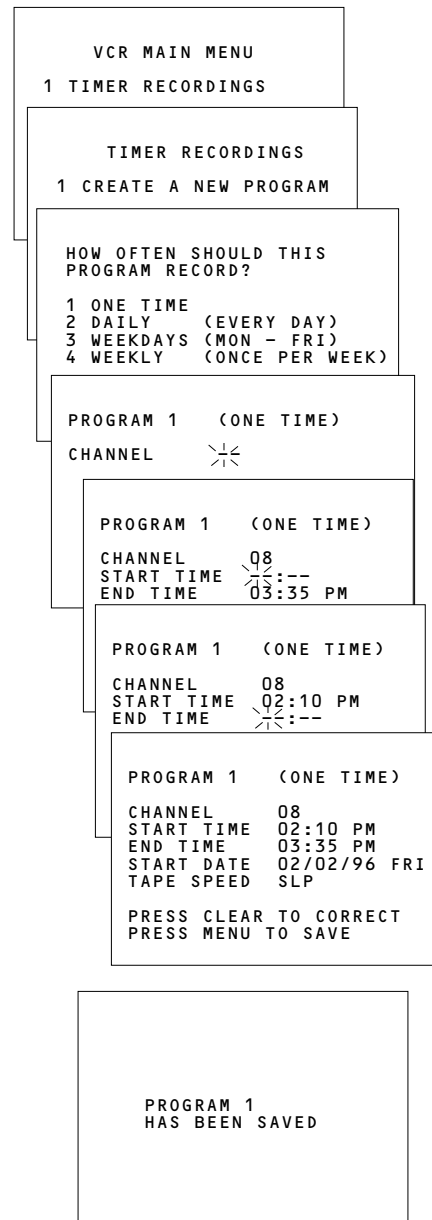

Stopping a Timer Recording

With the VCR: Press POWER and then STOP•EJECT within a few seconds.

With the Remote: Press VCR and then STOP within a few seconds.

Recording While You're Away (Timer Recording)

Timer Recording From the VCR's Line Input

The line input refers to the signal coming from the VCR's AUDIO and VIDEO IN jacks. Recording from the line input is convenient if you have a satellite receiver or similar component attached to these jacks.

To timer record from the component connected to the VCR's line input, press INPUT on the remote to enter VIDEO IN instead of the channel number on the TV screen during timer programming.

```
PROGRAM 1 (ONE TIME)
CHANNEL      VIDEO IN
START TIME  >7:--
END TIME    --:--
START DATE  --/--/--
TAPE SPEED  SLP

PRESS CLEAR TO CORRECT
PRESS MENU TO EXIT
```

Checking or Clearing Timer Recordings

1. Press MENU on the remote to display the VCR MAIN MENU.
2. Press 1 to display the TIMER RECORDINGS menu.
3. Press 2 to display the REVIEW EXISTING PROGS menu. Each entered program is displayed for a few seconds in sequence.
4. Press MENU or 2 or DISPLAY to display information faster.
5. Press CLEAR on the remote when the program you want to erase appears on the screen.

```
VCR MAIN MENU
1 TIMER RECORDINGS
```

```
TIMER RECORDINGS
1 CREATE A NEW PROGRAM
2 REVIEW EXISTING PROGS.
```

```
PROGRAM 1 (ONE TIME)
CHANNEL      08
START TIME   02:10 PM
END TIME     03:35 PM
START DATE   02/02/96 FRI
TAPE SPEED   SLP

PRESS CLEAR TO DELETE
PRESS MENU FOR NEXT PROG
```

Using Two VCRs for Copying and Editing Tapes

Operating Instructions (Refer to hookup on page 6.)

Use one VCR as the playback VCR and the other as the recording VCR.

1. Turn on the TV and VCRs.
 2. Tune the TV to the VCR viewing channel, either 3, 4, or the TV's video input.
 3. If you connected your VCR using Option A (page 6), tune the recording VCR to channel 3 or 4 – the one selected on the back of the playback VCR.
If you connected your VCR using Option B (page 6), press INPUT on the recording VCR's remote to select the line input. L appears in VCR's display panel.
 4. Insert the tape you want to copy into the playback VCR. Insert a blank tape with its safety tab in place into the recording VCR.
 5. Press PLAY•PAUSE, then PLAY•PAUSE on playback VCR when you reach the point on the tape or program where you want to begin copying. If the tape was not recorded on the playback VCR, streaks may appear, and you may need to adjust tracking.
 6. Press RECORD on the VCR or REC on the remote, then PLAY•PAUSE on the recording VCR.
 7. Press the PLAY•PAUSE buttons on both VCRs at the same time to begin copying the tape.*
 8. Edit out segments that you do not want to copy by pressing PLAY•PAUSE on the recording VCR to stop copying the tape. Then, locate the next segment you want to copy on the playback VCR by using FWD, REW and PLAY. Press PLAY•PAUSE on the playback VCR. Press PLAY•PAUSE at the same time on both VCRs to resume copying.
 9. Press STOP•EJECT on both VCRs when you are finished.
- * You may turn off the TV after the recording has started as it does not have to be on to copy a tape.

Caution: The unauthorized recording of television programs and other materials may infringe the rights of others.

Copying and Editing Tapes Using Compatible Remote

If you have a compatible RCA or ProScan remote with VCR1 and VCR2 buttons, you can program this VCR to respond to either VCR1 or VCR2. This lets you control both VCRs with one remote for easier copying and editing.

Set the REMOTE CONTROL feature of this VCR to VCR1 or VCR2 position. The compatible remote then controls the VCR with either the VCR1 or VCR2 button — depending on the position you select in the menu.

1. Press MENU to display the VCR MAIN MENU.
2. Press 4 to display the PREFERENCES menu.
3. Press 1 to activate the REMOTE CONTROL: VCR1 or VCR2 feature.
4. Press VCR1 or VCR2 on your compatible VCR's remote to change the setting and program this VCR to respond to VCR1 or VCR2 — depending on the position you selected in step 3.

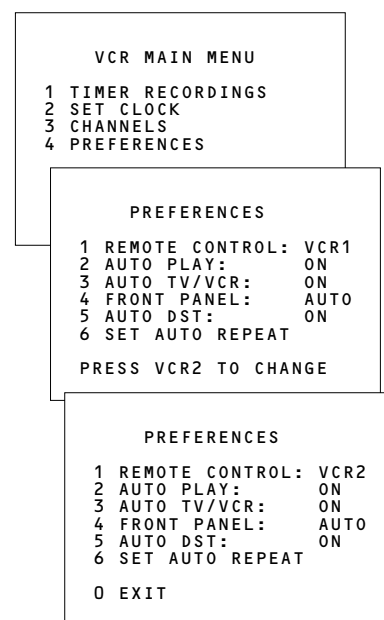

Location of Controls

Front Panel

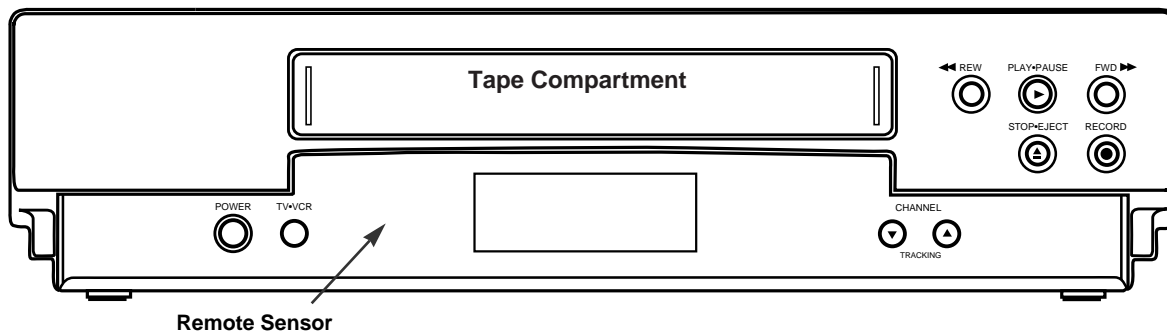

CHANNEL or TRACKING up or down

Selects next higher or lower channel in the VCR's channel memory.

Adjusts tracking during playback.

FWD (Fast-Forward)

Fast-forwards the tape when the VCR is stopped.

Searches the picture forward during playback.

PLAY•PAUSE

Plays a tape.

Pauses the tape for stop-action viewing during playback.

Pauses the tape during recording to prevent recording unwanted material.

POWER

Turns the VCR on or off.

RECORD

Starts the VCR recording.

Remote Sensor

Receives signals from the remote control. Aim the remote at this sensor with no objects between them.

REW (Rewind)

Rewinds the tape when the VCR is stopped.

Searches the picture in reverse during playback.

STOP•EJECT

Stops the VCR's normal functions such as record, playback, rewind, fast-forward, or pause.

Press when the VCR is stopped to eject the cassette.

TV•VCR

Switches the picture signal so that it either comes from the VCR or the TV channel. See page 10.

Back Panel

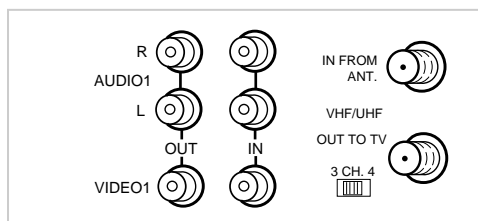

3 CH. 4 Switch

Selects the channel to which you tune the TV to see the VCR picture if you connect the VCR using one of the basic hookups.

IN FROM ANT. (Antenna) Connector

Receives a signal from an antenna or cable system when attached.

OUT TO TV Connector

Passes the signal to the TV using the supplied cable.

VIDEO1 and AUDIO1 (R and L) IN Jacks

Receives signals from another component, such as a VCR or camcorder, when it is connected to these jacks.

Press INPUT on the remote to select and use these jacks.

VIDEO1 and AUDIO1 (R and L) OUT Jacks

Sends signals from the VCR to another component, such as a monitor TV or another VCR, when it is connected to these jacks.

If the other component is not stereo, you may need a Y-adaptor to hear both channels.

Location of Controls

Display Panel

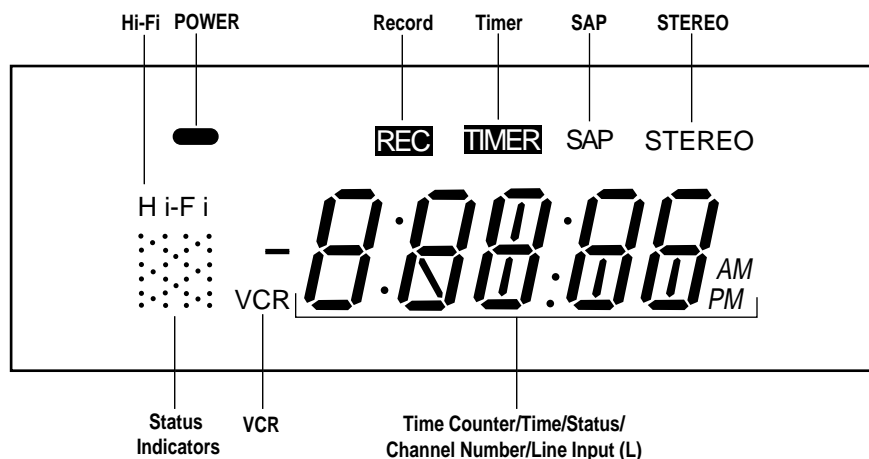

Hi-Fi Indicator

Lights when the AUDIO PLAY feature is set to HIFI or MIX.

POWER Indicator

Lights when power is turned on.

SAP Indicator

Lights when the station you are tuned to is broadcasting Second Audio Program.

Status Indicators

Show what the VCR is doing:

REC and ►	Record
REC and ■■	Record-pause
►	Playback
■■	Play-pause
■■	Frame advance
■►	Slow motion
► flashing	Rewind
► flashing	Reverse search
► flashing	Fast forward
► flashing	Forward search
■■ flashing	Cassette ejecting
FF	Fast Forward
PLAY	Playback
REC	Record
REP	Auto-repeat
REW	Rewind
STOP	Stop

STEREO Indicator

Lights when the station you are tuned to is broadcasting stereo.

Time Counter/Time/Status/ Channel Number/Line Input(L)

Shows the displays for the time counter, time, status, channel number, line input(L).

Press DISPLAY on remote to show these indicators. Also, press DISPLAY to switch between the current time and elapsed-time counter.

REC Indicator

Lights when VCR is set for timer recording and VCR is turned off. Flashes if tape is not inserted.

VCR Indicator (Applies Only to Basic Hookups)

Press TV•VCR to turn on or off.

VCR indicator on: Picture from VCR.

VCR indicator off: Picture from TV channel.

Specifications

Format:	VHS
Record/Playback System:	Video: 4-Head Audio: VHS Hi-Fi Stereo record/playback system
Video Signal System:	EIA standard: NTSC color
Antenna:	75-ohm external VHF/UHF combined antenna terminal
Tuner:	USA: 181 channels capability* (125 cable channels) Canada: 178 channels capability* (122 cable channels)
Type:	AutoProgramming frequency synthesis
Power Requirement:	120V AC, 60 Hz
Power Consumption:	23 watts
Dimensions:	3.5 inches high (89 mm) 15 inches wide (380 mm) 11.2 inches deep (285 mm)
Weight:	8.4 pounds (3.8 kg)
Storage Temperature Range:	- 22°F to +149°F
Operating Temperature Range:	+41°F to +104°F

*Check your cable company's compatibility requirements.

Cleaning the VCR

Use a soft cloth or dusting attachment of your vacuum cleaner to dust your VCR. Remove dust from the ventilation holes on the top, back, sides, and bottom of the cabinet.

Plastic surfaces are easily scratched and can be marred by alcohol and various solvents. Avoid excessive use of oil-based furniture polishes since the materials used in the cabinet will accumulate more dust. We recommend using a non-abrasive, anti-static cleaner and polisher.

Trouble Checks

Sometimes problems can be easily solved by checking a few basic things. Check below before you call for help or take your VCR to an Authorized RCA VCR Servicenter.

Trouble	Here's what to try:
No power	<ul style="list-style-type: none"> • Plug VCR into an operating outlet. • Check connections.
VCR does not respond to remote	<ul style="list-style-type: none"> • Remove batteries and hold down one or more buttons for several seconds to drain the microprocessor inside the remote and reset it. Re-install the batteries and try remote again. • Press VCR to set remote to control the VCR. <i>See page 12.</i> • Aim remote at VCR with no objects between them. • Change batteries.
Remote no longer controls an RCA TV	<ul style="list-style-type: none"> • Press TV to set remote to control a compatible TV. <i>See page 14.</i> • Reprogram remote for RCA TV. <i>See page 14.</i>
Remote no longer controls a compatible TV	<ul style="list-style-type: none"> • Press TV, or CABLE to set remote to control the corresponding component. <i>See pages 14-15.</i> • Aim remote at TV with no objects between them. • Reprogram remote after batteries have been changed. • Change batteries.
Poor or no picture for normal TV viewing	<ul style="list-style-type: none"> • Press TV•VCR to turn VCR indicator off. • Switch TV to an active channel. • Check antenna connections.
Snowy or no picture during playback	<ul style="list-style-type: none"> • Press TV•VCR to turn VCR indicator on. • Check TV channel selected (3 or 4) to make sure it matches the channel selected with 3CH.4 switch on back of VCR. • Check TV's fine tuning. • Check video cable connections between VCR and TV monitor. • Set TV monitor to video input channel. • Try another tape. • Some snow/streaks are normal during search, stop action, frame advance, and slow-motion playback.
Streaks in picture during normal playback	<ul style="list-style-type: none"> • Press TRACKING to move streaks for the best picture. • Check tape — it may be worn out or of poor quality.
Time counter not working	<ul style="list-style-type: none"> • The time counter does not advance during unrecorded portions of tape. When an unrecorded segment of tape is encountered, the time counter will hold its count until recorded material is detected again. • A minus (-) appears in front of the time if you rewind the tape farther back than a counter reading of 0:00:00.
Will not record or play	<ul style="list-style-type: none"> • No cassette in VCR. • Eject and reinsert cassette. • Broken tape — try another cassette. • VCR is in pause mode. Press PAUSE on the remote or PLAY•PAUSE on the VCR during recording or playback.
Will not record	<ul style="list-style-type: none"> • Safety tab removed from cassette. • Make sure the line indicator (L) is turned off in VCR's display panel for normal recording from the VCR's tuner. Press INPUT on the remote to turn the line input off.
Stereo or SAP sound not recorded	<ul style="list-style-type: none"> • RECEPTION: STEREO/SAP/MONO feature must be set to STEREO to record broadcast stereo. <i>See page 26.</i> • RECEPTION: STEREO/SAP/MONO feature must be set to SAP to record SAP. <i>See page 26.</i>

Trouble Checks

Trouble	Here's what to try:
Rewind does not operate	<ul style="list-style-type: none"> • STEREO or SAP indicator not on. Station not broadcasting stereo or SAP. • Tape already rewind.
Timer recording not made or wrong program recorded	<ul style="list-style-type: none"> • Cable box was not turned on at time recording was to begin. • Program entered incorrectly (wrong channel or times). • Power interruption. Reset clock. <i>See page 11.</i> • Check to see if time and date are correct — including AM/PM. • Program exceeded tape's length or tape was not rewind beforehand. • VCR was not turned off at the time recording was to start. • No tape in VCR or cassette's safety tab broken off.
Clock shows incorrect time or date	<ul style="list-style-type: none"> • Power interruption. Clock on the front panel will show --:--. • Clock was not set accurately (check AM/PM and date). <i>See page 11.</i> • Time counter display appears in VCR's display apnel. Press DISPLAY on remote.
Time did not adjust for daylight savings.	<ul style="list-style-type: none"> • Check to see if AUTO DST is turned on.
VCR makes noise when stopped	<ul style="list-style-type: none"> • VCR is removing tape from heads. This is normal. The head cylinder inside the VCR continues to rotate for a few minutes after you put the VCR in the stop mode.
Will not AUTO-SEARCH active channels correctly	<ul style="list-style-type: none"> • Check antenna connections. • Check SIGNAL TYPE: CABLE/ANTENNA feature. <i>See page 9.</i>
Cannot add or remove channels	<ul style="list-style-type: none"> • Channels must be placed in memory using AUTO CHANNEL SEARCH feature before channels can be added or removed from channel memory. <i>See page 9.</i>
Cannot select channels over 69	<ul style="list-style-type: none"> • Cable channels over 69 can only be selected if SIGNAL TYPE: CABLE/ANTENNA feature is set to CABLE. <i>Details are on page 9.</i>
Cassette with safety tab removed does not start to play automatically	<ul style="list-style-type: none"> • Set AUTO PLAY ON/OFF feature to ON. <i>Details are on page 17.</i>
Tape plays back in slow motion	<ul style="list-style-type: none"> • Press SLOW•F. ADV or PLAY to return to normal playback.
TIMER indicator flashes	<ul style="list-style-type: none"> • Timer recording programmed and no cassette in VCR.
On-screen menus are in Spanish	<ul style="list-style-type: none"> • LANGUAGE/LENGUA feature set to SPANISH. <i>See page 10.</i>
Time counter disappears while searching	<ul style="list-style-type: none"> • This is normal. <i>Details are on page 18.</i>
No stereo sound during playback	<ul style="list-style-type: none"> • TAPE PLAYBACK: HI-FI/MIX/LINEAR feature must be set to HI-FI to hear stereo sound during playback. <i>See page 23.</i>
Stereo audio too noisy	<ul style="list-style-type: none"> • Stereo signal is weak. Set RECEPTION: STEREO/SAP/MONO feature to MONO. • Press TRACKING up or down on the remote to minimize the noise.
Tape plays over and over	<ul style="list-style-type: none"> • Check setting of SET PLAYBACK LOOP menu. <i>See page 17.</i>

Limited Warranty

What your warranty covers:

- Any defect in material or workmanship.

For how long after your purchase:

- Ninety days for labor charges.
- One year for parts.

The warranty period for rental units begins with the first rental.

What we will do:

- Pay any Authorized RCA VCR Servicenter the labor charges to repair your VCR.
- Pay any Authorized RCA VCR Servicenter for the new or, at our option, refurbished replacement parts required to repair your VCR.

How you get service:

- Take your VCR to any Authorized RCA VCR Servicenter. To identify your nearest Authorized RCA VCR Servicenter, ask your dealer, look in the Yellow Pages, or call 1-800-336-1900.
- Show the service technician your evidence of purchase date.
- Pick up your VCR when repairs are completed.

What your warranty does not cover:

- Customer instruction. (Your Owner's Manual clearly describes how to install, adjust, and operate your VCR. Any additional information should be obtained from your Dealer.)
- Installation and related adjustments.
- Signal reception problems not caused by your VCR.
- Damage from misuse or neglect.
- Cleaning of video/audio heads.
- Remote control batteries.
- A VCR that has been modified or incorporated into other products or is used for institutional or other commercial purposes.
- A VCR purchased or serviced outside the USA.
- Acts of God, such as but not limited to lightning charge.

Product Registration:

- Please complete and mail the *Product Registration Card* packed with your VCR. It will make it easier to contact you should it ever be necessary. The return of the card is not required for warranty coverage.

How state law relates to this warranty:

- This warranty gives you specific legal rights, and you also may have other rights that vary from state to state.

If you purchased your VCR outside the United States:

- This warranty does not apply. Contact your dealer for warranty information.

Index

- + and – Buttons.....12,13,19
- 3CH.4 Switch.....3-9,31
- Accessories, Included.....8
- Add or Remove Channels from
 - Memory.....9
- ADD/REMOVE CHANNEL Menu.....9
- Amplifier/Receiver Connections.....7
- Antenna Connections.....2,3
- AUDIO Menu.....23,26,27
- Audio Only, Recording.....27
- AUDIO1/VIDEO1 IN
 - Jacks.....6,7,23,27,30,31
- AUDIO1/VIDEO1 OUT Jacks.....3-7,30,31
- AUTO CHANNEL SEARCH Feature.....9
- AUTO DST Feature.....11
- AUTO TV/VCR Feature.....10
- AUTO PLAY Feature.....17
- AUTO REPEAT Feature.....17
- Automatic Tracking.....20
- Back Panel.....31
- Batteries, Inserting in Remote.....8
- Blank Search Feature.....22
- BLANK SEARCH Menu.....22
- CABLE Button.....15
- Cable Box Function Buttons.....13
- Cable Box, Programming Remote.....15
- Cable System With Cable Box
 - Connections.....2,4,5
- Cable System Without Cable Box
 - Connections.....2,3
- Card, Registration.....i
- CHAN Up or Down Buttons.....9,10,12,14
- CHANNEL Buttons.....31
- CHANNELS Menu.....9
- Checking Timer Recordings.....29
- Checks, Trouble.....34-35
- Choosing a Hookup.....2
- Cleaning the VCR.....33
- CLEAR Button.....11,12,28,29
- Clearing Timer Programs.....29
- Commercial Scan.....21
- Compatible Remotes.....30
- Connections.....2-7
 - Antenna.....2-3
 - Amplifier/Receiver.....2,7
 - Audio/Video Jacks.....2,3-7
 - Cable-TV.....2,4-5
 - Two VCRs.....6
- Contents.....1
- Controlling a TV with Remote.....14
- Copying Tape, Connections.....6
- Copying and Editing Tapes.....30
- Date and Time, Setting.....11
- Design Specifications.....33
- DISPLAY Button.....12,18,22
- Display Panel.....32
- Editing and Copying Tapes.....30
- Español.....11
- Express (XPR) Recording.....25
- FF (Fast Forward) Button.....18,19,22,30,31
- FWD (Fast Forward) Button.....30,31
- First-Time Operation.....8-11
- Frame Advance Feature.....19
- Front Panel.....31
- Hi-Fi Indicator.....23,32
- Hookups
 - Antenna.....2-3
 - Amplifier/Receiver.....2,7
 - Audio/Video Jacks.....2,3-7
 - Cable-TV.....2,4-5
 - Two VCRs.....6
- Hookup, Choosing.....2
- IDIOMA/LANGUAGE Menu.....11
- IN FROM ANT. Connector.....3-5,31
- INDEX Feature.....21
- INDEX SEARCH Menu.....21
- INPUT Button.....12,28,29
- LANGUAGE/IDIOMA Menu.....11
- Language, Selecting.....11
- Limited Warranty.....36
- Line Input, Recording From.....29
- Location of Controls
 - Remote Control.....12-13
 - VCR Back Panel.....31
 - VCR Front Panel.....31
 - VCR Display Panel.....32
- LP Speed.....24
- Manual Tracking.....20
- MENU Button.....8-12,17,23,26-30
- Number Buttons.....12-15
- Operating Instructions
 - Audio Only Recording.....27
 - Broadcast Stereo TV Recording.....26
 - Copying Tapes.....30
 - Express Recording.....25
 - Playing a Tape.....16
 - Recording a Program.....24
 - SAP Recording.....26
 - Timer Recording.....28
- Operation, First Time.....8-11
- OUT TO TV Connector.....3-5,31
- PANEL DISPLAY Feature.....10
- PAUSE Button.....12,20,24
- Pause for Stop Action.....19
- Pause, Recording.....24
- Picture Search.....19
- PLAY Button.....12,16,17,19,20,22,31
- PLAY+PAUSE Button.....20,24,31
- TAPE PLAYBACK: HI-FI/ LINEAR/MIX
 - Feature.....23,26
- Playing a Tape.....16-23
- POWER Button.....12-15,25,28,31
- POWER Indicator.....32
- PREV CH (Previous Channel)
 - Button.....12-13
- Problems, Solving.....34-35
- Product Registration.....i
- Programming Remote for Cable Box.....15
- Programming Remote to Control TV.....14
- RECEPTION: STEREO/MONO/SAP
 - Feature.....26,27
- REC Button.....12-13,24-27,30
- RECORD Button.....24-27,30,31
- RECORD Indicator.....24-27,32
- Recording
 - Audio Only.....27
 - Basic.....24
 - Broadcast Stereo TV.....26
 - Express.....25
 - From Another VCR.....30
 - One Program While
 - Watching Another.....24
 - Pause.....24
 - SAP (Second Audio Program).....26
 - Speeds.....24
 - Timer.....28-29
 - Types Of.....24
- Registration Card.....i
- REMOTE CONTROL Feature.....30
- Remote Control.....12-13
- Remote Sensor.....31
- Remove or Add Channels from
 - Memory.....9
- REMOVE/ADD CHANNEL Menu.....9
- Review Programs Feature.....29
- REW Button.....12-13,16,19,21,22,30
- Safety Precautions.....i
- SAP Indicator.....26,32
- SAP, Recording.....26
- SEARCH Button.....12-13,21,22
- Searching, Picture.....19
- Seleccione el Idioma.....11
- Sensor, Remote.....31
- SET CLOCK Menu.....11
- Setting a Timer Recording.....28
- Setting Up the VCR.....8-11
- PREFERENCES Menu.....10,11,17,30
- SIGNAL TYPE Feature.....9
- SLOW*F.ADV (Frame Advance)
 - Button.....13,20
- Slow Motion.....19
- SLP Speed.....24
- Solving Problems.....34-35
- SP Speed.....24
- Specifications.....33
- SPEED Button.....12-13,24-28
- Speeds, Recording.....24
- Startup.....8-11
- STEREO Indicator.....26,32
- Stereo Amplifier/Receiver
 - Connections.....7
- Stereo TV, Recording.....26
- Stop Action Pause.....19
- STOP Button.....12-13,16,18,22,24-28
- STOP+EJECT Button.....16,24-28,30
- Stopping a Recording.....25
- Stopping a Timer Recording.....28
- Table of Contents.....1
- Time and Date, Setting.....11
- Time Counter.....18
- TIMER Indicator.....25,28,32
- Timer Recording
 - Checking and Clearing.....29
 - Front VCR Line Input.....29
 - Recording.....28
 - Setting.....28
 - Stopping.....28
- Tracking, Automatic and Manual.....20
- TRACKING Button.....12-13,16,19,20,31
- Trouble Checks.....34-35
- Turn On VCR.....8
- TV Button.....12-13,14
- TV Function Button.....13
- TV*VCR Button.....10,12-13,24,31
- VCR Controls.....31
- VCR Button.....13
- VCR Function Button.....12-13,15
- VCR Indicator.....8,10,16,24,32
- VCR MAIN MENU.....9-11,17,23,26-30
- VCR, Cleaning.....33
- VCR, Turn On.....8
- VCR1/VCR2 Feature.....30
- VCRs Memory, Placing Channels.....9
- VCRs, Connecting for Tape Copying.....6
- VIDEO1 IN Jacks.....6,7,27,29,31
- VIDEO1 OUT Jacks.....3-7,31
- Warranty, Limited.....36
- Zero Search.....22

For your nearest Home
Entertainment Dealer
or Authorized Servicenter
call toll-free in the U.S.A.

1-800-336-1900

Canadian Consumers –
Your toll free numbers are:

English: 1-800-522-0338

French: 1-800-522-0445

If you would like a copy of this manual in French, please follow the
instructions below:

Si un livret d'instructions en français n'est pas inclus avec votre appareil, vous
pouvez en obtenir un (indiquer le numéro de modèle, votre nom, et votre
adresse) en vous adressant à:

Thomson Consumer Electronics
Attention: Canadian Operations
P.O. Box 0944
Indianapolis, IN 46206-0944

If your VCR needs service, please contact your dealer or the nearest
Servicenter from the yellow pages. Please do not send any products
to the Indianapolis address listed in this manual or on the carton.
This will only add delays in service for your product.

 **THOMSON CONSUMER ELECTRONICS**
10330 North Meridian Street
Indianapolis, IN 46290-1024

©1995 Thomson Consumer Electronics, Inc.

Trademark(s)[®] Registered

Marca(s) Registrada(s)

Printed in Japan

Part Number 95-VR613HF-1

VQTS3137 (A)